



**SPECIAL LITE**  
QUALITY OUTDOOR PRODUCTS SINCE 1967

## Outdoor Lighting Mailboxes Site Furnishings

Residential Lighting

Street and Area Lighting

LED Bulbs

Curbside Mailboxes

Wall Mount Mailboxes

Cluster Box Units (CBU's)

Address Plaques

Message Boards

Bollards

*and much more*



**1-800-365-0511**  
**[www.specialliteproducts.com](http://www.specialliteproducts.com)**

# COMPANY HISTORY AND TABLE OF CONTENTS

## Industry leader in quality outdoor products since 1967.

Since 1967, Special Lite Products LLC has been a leader in designing, manufacturing, and importing decorative outdoor products.

As we strive to maintain our leadership in the industry, we are proud to introduce the next chapter in our product evolution. Not only will you find the proven best sellers that you are familiar with, but a number of new products that are sure to grab your attention, as well.

Our in-house product designers work with the goal of offering you the most innovative and long lasting products, at an excellent value. Your complete satisfaction is our ultimate goal.

All of us at Special Lite Products LLC appreciate the trust you've had in our company, our products and our service since 1967. We look forward to writing the next chapter in our history together with you.

Sincerely,

*Special Lite Products LLC*

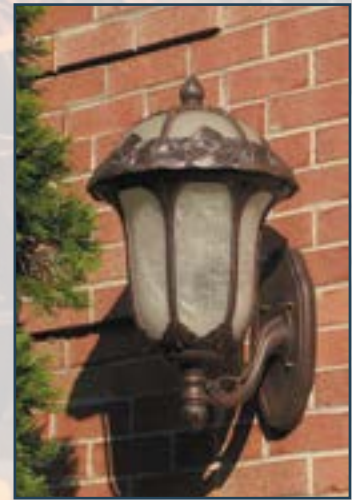

## TABLE OF CONTENTS

### **STREET AND AREA LIGHTING**

	<b><u>PAGE NUMBER</u></b>
Street and Area Lighting Combinations.....	4 - 5
Acorn and Sphere Lighting.....	6
LED Lighting.....	7
Street and Area Light Poles.....	8
Replacement Globes.....	9
Street and Area Lighting Accessories.....	9

### **RESIDENTIAL LIGHTING**

	<b><u>PAGE NUMBER</u></b>
Abington Series.....	12 - 13
Accord Series.....	14 - 15
Astor Series.....	16 - 17
Brentwood Series.....	18 - 19
Caldwell Series.....	20 - 21
Claremont Series.....	22 - 23
Floral Series.....	24 - 25
Glenn Aire Series.....	26 - 29
Plantation Series.....	30 - 31
Rose Garden Series.....	32 - 35
Sonoma Series.....	36 - 37
Vista Series.....	38 - 39
Direct Burial Light Posts and Accessories.....	40
Surface Mount Light Posts and Accessories...	41

### **CURBSIDE MAILBOXES, POSTS AND ACCESSORIES**

	<b><u>PAGE NUMBER</u></b>
Curbside Mailboxes.....	44 - 55
Curbside Mailbox Accessories.....	56
Lock Box Inserts.....	57
Surface Mount / Direct Burial Mailbox Posts.....	58 - 59
Direct Burial Mailbox Posts.....	60 - 63

### **ADDITIONAL MAILBOXES**

	<b><u>PAGE NUMBER</u></b>
PRO-SERIES™ Mailbox Systems.....	66 - 71
Multi-Unit Mailboxes.....	72
4B and 4C Mailboxes.....	73
Cluster Box Units.....	73
Wall Mount Mailboxes.....	74 - 75

### **ADDRESS PLAQUES AND SITE FURNISHINGS**

	<b><u>PAGE NUMBER</u></b>
Address Plaques.....	78 - 79
Bollards.....	80
Pet Waste Stations.....	80
Message Boards / Letter Boards.....	81

### **ORDERING INFORMATION**

	<b><u>PAGE NUMBER</u></b>
How To Order.....	82
Finish Options.....	82
Index.....	83 - 85
Terms and Conditions.....	See Price Sheet

# STREET AND AREA LIGHTING

# STREET AND AREA LIGHTING



# STREET AND AREA LIGHTING COMBINATIONS

Whether you are a builder creating a master planned community, an architect developing a new lifestyle center or redeveloping a historic streetscape, we offer the quality and style you've been looking for. Decorative outdoor lighting fixtures can increase property values and bring a uniform appearance to both established and new communities. Our outdoor light poles, bases and accessories are constructed of rust free cast and extruded aluminum. Some of our most popular commercial lighting combinations are shown below.



Model #: MP-412 w/AD / WRB6 / SHD1-PC2020CL

Model #: MP-412 w/AD / WRB6 / SHD1-PC1023CL / PFIN

Model #: MP-612 w/AD / WRB9 / TSB15 / SHD1-PC1023CL / SR / PFIN

Model #: PSM-MP-612 w/AD / WRB11 / SHD1-AC1026CL-TYPE III / PFIN

Model #: MP-412 w/AD / WRB1 / SHD1-PC1023CL / PFIN / TSB-201-1824

See page 82 for finish options

# ACORN AND SPHERE LIGHTING

We offer a large selection of acorn and sphere globe fixtures in incandescent light sources. These quality lighting fixtures are manufactured from Cast Aluminum with enclosed ballast and stainless steel hardware. Medium base sockets accept our replacement LED bulbs. See page 7 for LED bulb details. TSB-15 (4" to 3" Pole Adapter) required if using with a 4" O/D pole (sold separately).

## 16" POLYCARBONATE GLOBE LIGHT FIXTURES

MODEL # 2810-PC1016CL



**Model #:**  
2810-PC1016CL-INCAN

**Model #:**  
2817-PC1016CL-INCAN

MODEL # 2817-PC1016CL



**Description:** 300 Watt Incan.  
**Voltage:** 120  
**Socket:** Medium  
**Bulb Included:** No

## 26" ACRYLIC GLOBE WITH TYPE V DISTRIBUTION LIGHT FIXTURE

MODEL # SHD1-AC1026CL-TYPE V



**Model #:**  
SHD1-AC1026CL-TYPE V-INCAN

**Description:** 300 Watt Incan.  
**Voltage:** 120  
**Socket:** Medium  
**Bulb Included:** No

**Type V Distribution:**



Optic

## 23" POLYCARBONATE GLOBE LIGHT FIXTURES

MODEL # SHD1-PC1023CL



**Model #:**  
SHD1-PC1023CL-INCAN

**Description:** 300 Watt Incan.  
**Voltage:** 120  
**Socket:** Medium  
**Bulb Included:** No

MODEL # SHD1-PC1023CL shown with a W7317



(W7317 sold separately)

**PFIN and SR Finial and Solid Roof**  
Optional accessories  
See page 9 for details



## 26" ACRYLIC GLOBE WITH TYPE III DISTRIBUTION LIGHT FIXTURE

MODEL # SHD1-AC1026CL-TYPE III



**Model #:**  
SHD1-AC1026CL-TYPE III-INCAN

**Description:** 300 Watt Incan.  
**Voltage:** 120  
**Socket:** Medium  
**Bulb Included:** No

**Type III Distribution:**



Optic

## 26" POLYCARBONATE GLOBE LIGHT FIXTURE

MODEL # SHD1-PC1026CL



**Model #:**  
SHD1-PC1026CL-INCAN  
**Description:** 300 Watt Incan.  
**Voltage:** 120  
**Socket:** Medium  
**Bulb Included:** No



**DSR-360-MED Dark Sky Reflector**  
Optional accessory  
See page 9 for details

## ACRYLIC SPHERE LIGHT FIXTURES

MODEL # 2790-AC3010 (shown)

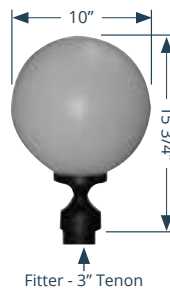

**Post Mount Model #'s:**  
2790-AC3010 (10" Globe)  
2790-AC3012 (12" Globe)

**Wall Mount Model #'s:**  
2797-AC3010 (10" Globe)  
2797-AC3012 (12" Globe)

MODEL # 2797-AC3010 (shown)



**Description:** 100 Watt Incan.  
**Socket:** Medium  
**Bulb Included:** No

See page 82 for finish options

## Smart LED Lighting

Consumers all over the world are converting streetlights to low-energy Light Emitting Diode (LED) fixtures, and for good reason. LED's offer the highest energy savings of any light source available.

In addition, LED's emit directional light, which means more control over what is illuminated (streets and sidewalks) and what is not (the night sky).

Our LED bulbs are able to be used with commercial acorn and sphere globes as well as many residential cast aluminum light fixtures. Bulbs can also be used to retrofit existing HID ballast light fixtures.



**Compact Bulb**

2 3/4" Dia. x 5" H

**Model #:**

**B-127-E26 (15w Bulb)**

Applicable for use with:  
Residential Light Fixtures



**Small Bulb**

3 1/2" Dia. x 6 1/4" H

**Model #:**

**B-130-E26 (20w Bulb)**

**B-135-E26 (30w Bulb)**

**B-140-E26 (40w Bulb)**



**Medium Bulb**

3 1/2" Dia. x 8 5/8" H

**Model #:**

**B-145-E26 (50w Bulb)**

**B-153-E26 (65w Bulb)**

Accessory used to make medium base (E26) LED bulbs compatible for mogul base (E39) sockets.



**Medium Bulb to Mogul Base Adapter**

**Model #:**

**MOG-ADPT**

Model #	Wattage	Voltage	Size	Lamp Base	Lumens	Color Temp	Equivalent
<b>B-127-E26</b>	15	120-277	2 3/4" Dia. 5" H	MED. E26	1,600 lm	5500K	100w INCAN.
<b>B-130-E26</b>	20	120-277	3 1/2" Dia. 6 1/4" H	MED. E26	1,800 lm	5500K	70w MH / HPS
<b>B-135-E26</b>	30	120-277	3 1/2" Dia. 6 1/4" H	MED. E26	2,700 lm	5500K	100w MH / HPS
<b>B-140-E26</b>	40	120-277	3 1/2" Dia. 6 1/4" H	MED. E26	3,800 lm	5500K	150-175w MH / HPS
<b>B-145-E26</b>	50	120-277	3 1/2" Dia. 8 5/8" H	MED. E26	4,800 lm	5500K	200w MH / HPS
<b>B-153-E26</b>	65	120-277	3 1/2" Dia. 8 5/8" H	MED. E26	7,000 lm	5500K	250w MH / HPS
<b>MOG-ADPT</b>	Medium Bulb to Mogul Base Adapter (E26 to E39)						

Other color temperatures available upon request.

## LED Energy Cost Savings & Return on Investment (ROI)

40 watt LED Replacement Bulb versus 175 watt Metal Halide Bulb.

### Metal Halide 175 Watt Bulb:

- Power Consumption: 210 watt (approx.)
- Note: Above results are estimated. Total power larger than lamp ratings due to ballast losses.*

VS.

### LED 40 Watt Bulb:

- Power Consumption: 41 watt max.
- Note: Actual measurements including self-ballast losses.*

### Energy Reduction = 169w/hr (210w of MH - 41w of LED Bulb)

- Daily Energy Reduction: 4.05KW (24 x 169/1,000 @ 24hrs/day)
- Yearly Energy Reduction: 1,478KW (4.05 x 365 days per year)
- **Yearly Cost Savings: \$236.00 (1,478 x \$0.16/KW)**

*Note: Calculated at 16 cents per KW*

**ROI: Approximately 2 years, operating at 12 hours per day.**

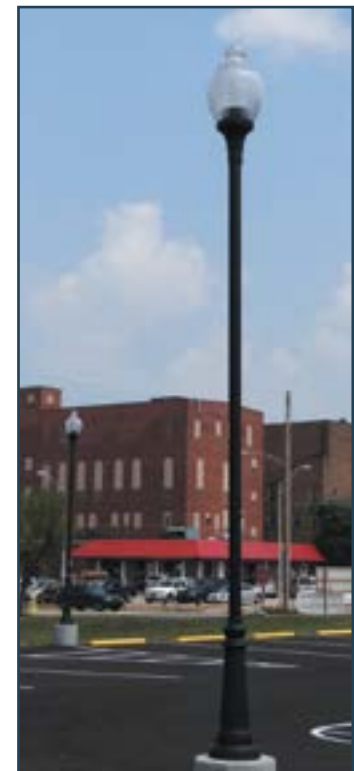

# STREET AND AREA LIGHT POLES

## 3" O/D LIGHT POLE OPTIONS

3" O/D Smooth Pole with Access Door



Model Number:	Pole Length:
410 w/AD	10 ft.
412 w/AD	12 ft.
414 w/AD	14 ft.
416 w/AD	16 ft.

3" O/D Fluted Pole with Access Door



Model Number:	Pole Length:
MP-410 w/AD	10 ft.
MP-412 w/AD	12 ft.
MP-414 w/AD	14 ft.
MP-416 w/AD	16 ft.

3" O/D Smooth Pole Surface Mount with Access Door, J-Bolts Included



Model Number:	Pole Length:
PSM-408-w/AD	8 ft.
PSM-410-w/AD	10 ft.
PSM-412-w/AD	12 ft.

3" O/D Fluted Pole Surface Mount with Access Door, J-Bolts Included



Model Number:	Pole Length:
PSM-MP-408-w/AD	8 ft.
PSM-MP-410-w/AD	10 ft.
PSM-MP-412-w/AD	12 ft.

35" from the bottom of the access door to the bottom of the pole.

35" from the bottom of the access door to the bottom of the pole.

12" from the bottom of the access door to the bottom of the pole.

12" from the bottom of the access door to the bottom of the pole.

Ground Level

## 4" O/D LIGHT POLE OPTIONS

4" O/D Smooth Pole with Access Door



Model Number:	Pole Length:
608 w/AD	8 ft.
610 w/AD	10 ft.
612 w/AD	12 ft.
614 w/AD	14 ft.
616 w/AD	16 ft.

4" O/D Fluted Pole with Access Door



Model Number:	Pole Length:
MP-608 w/AD	8 ft.
MP-610 w/AD	10 ft.
MP-612 w/AD	12 ft.
MP-614 w/AD	14 ft.
MP-616 w/AD	16 ft.

4" O/D Smooth Pole Surface Mount with Access Door & 3" Tenon, J-Bolts Included

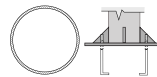

Model Number:	Pole Length:
PSM-608-w/AD	8 ft.
PSM-610-w/AD	10 ft.
PSM-612-w/AD	12 ft.
PSM-614-w/AD	14 ft.

4" O/D Fluted Pole Surface Mount with Access Door & 3" Tenon, J-Bolts Included



Model Number:	Pole Length:
PSM-MP-608-w/AD	8 ft.
PSM-MP-610-w/AD	10 ft.
PSM-MP-612-w/AD	12 ft.
PSM-MP-614-w/AD	14 ft.

35" from the bottom of the access door to the bottom of the pole.

35" from the bottom of the access door to the bottom of the pole.

12" from the bottom of the access door to the bottom of the pole.

12" from the bottom of the access door to the bottom of the pole.

Ground Level

See page 82 for finish options



# STREET AND AREA LIGHTING ACCESSORIES

## REPLACEMENT GLOBES



**PC-1016CL**  
10 3/4" W x 16 3/4" H  
Polycarbonate Globe  
6" Neck Opening



**PC-1023CL**  
14" W x 21 1/4" H  
Polycarbonate Globe  
8" Neck Opening



**PC-1026CL**  
16 5/8" W x 27" H  
Polycarbonate Globe  
8" Neck Opening



**PC-2020CL**  
15 1/2" W x 20" H  
Polycarbonate Globe  
8" Neck Opening



**AC-1026CL-Type III**  
15 3/4" W x 27" H  
Acrylic Globe  
8" Neck Opening



Type III  
Distribution



**AC-1026CL-Type V**  
15 3/4" W x 27" H  
Acrylic Globe  
8" Neck Opening



Type V  
Distribution

## LAMP ARMS

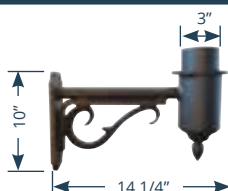

**W7317**  
**Wall Mount Lighting Arm**  
- Made of extruded and cast aluminum  
- 4 1/2" W x 10" H backplate  
- Decorative Scroll



**P7327**  
**Post Mount Double Lighting Arm**  
- Made of extruded and cast aluminum  
- Decorative Scrolls

## HOUSE SHIELDS / DARK SKY REFLECTORS

House side shields cut off direct light through certain horizontal angles.  
Dark sky reflectors cut off the amount of up light.

**HSS-90 (90 Degree Cutoff House Shield)**  
4 5/8" W x 7 15/16" H

**HSS-180 (180 Degree Cutoff House Shield)**  
6 7/8" W x 8 1/2" H

**DSR-360-MED (Dark Sky Reflector)**  
Fits Medium Base Sockets

**DSR-360-MOG (Dark Sky Reflector)**  
Fits Mogul Base Sockets

TOP VIEW

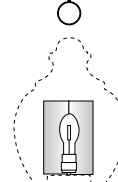

HSS-90

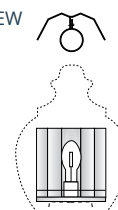

HSS-180



DSR-360-MED  
DSR-360-MOG

## BASES

### BASES FOR 3" O/D ROUND POLES



**WRB1**  
26" Height  
8" Dia.



**WRB2**  
26" Height  
6 3/4" Dia.



**WRB5**  
24" Height  
8" Dia.



**WRB6**  
32" Height  
11 3/4" Dia.



**WRB8**  
10 1/4" Height  
9 1/4" Dia.



**WRB17**  
16 1/4" Height  
7 3/4" Dia.

### BASES FOR 4" O/D ROUND POLES



**WRB9**  
32" Height  
11 3/4" Dia.



**WRB11**  
17 1/2" Height  
11 3/4" Dia.



**WRB16**  
13 1/2" Height  
7 3/4" Dia.

## COMMERCIAL LIGHTING ACCESSORIES



**PFIN**  
**Finial for Acorn Globe**  
Available in black only



**SR**  
**Solid Roof Adapter**  
Available for PC-1023CL & PC-1026CL. Must be used with PFIN.



**TSB15**  
**4" to 3" Pole Adapter**  
Easily attach light fitters to a 4" O/D pole



**CO-268**  
**Pole Electrical Outlet**  
Curved to fit 3" O/D pole. 1 1/4" hole required. 120 volt only.



**Dusk to Dawn Photo Electric Control**  
**Model #: PC-8010**  
120 Volt, 300 Watt Max  
**Model #: PC-8015**  
208-277 Volts, 1200 Watt Max



**Stub Post Base**  
**Model #: SPB-190**  
For use with 3" O/D Poles  
**Model #: SPB-690**  
For use with 4" O/D Poles  
8" Height, 10" Width  
J-Bolts Included

See page 82 for finish options



# RESIDENTIAL LIGHTING

# ABINGTON SERIES

The Abington Series incorporates several unique concepts to create an individual style. Each fixture has an alabaster glass lid, leaded stained glass panels, and sculptured cast aluminum arms and cage. These fixtures emit a warm and attractive glow that provides ample light for any entrance, porch or deck.

**Bottom Mount  
Wall Bracket**  
Shown in  
Swedish Silver (SW)





**Tri-Light**  
Shown in Black (BLK)



**Flush Mount**  
Shown in Copper (CP)



**Post Mount**  
Shown in Swedish Silver (SW)



**SAP-4180**  
Complementing Address Plaque  
See page 79 for details

Style	Size	Item #	Width	Height	Ext.	T/O	Back Plate	Glass Choice	Light Source	Finish Choices
Bottom Mount	Medium	F-2987	7"	15 1/4"	10"	10 3/4"	4 3/4" W x 8 1/2" H	Leaded Stained Glass	⦿	BLK / SW / CP
	Large	F-3987	8 3/4"	18 3/4"	10"	14 3/4"	4 3/4" W x 8 1/2" H	Leaded Stained Glass	⦿	BLK / SW / CP
	Estate	F-4987	10 1/2"	24"	12 3/4"	16 1/4"	7" W x 13 1/4" H	Leaded Stained Glass	⦿	BLK / SW / CP
Flush Mount	Medium	F-2753	10"	8"	--	--	--	Alabaster	⦿	BLK / SW / CP
Post Mount	Medium	F-2980	7"	16 3/4"	--	--	--	Leaded Stained Glass	⦿	BLK / SW / CP
	Large	F-3980	8 3/4"	20"	--	--	--	Leaded Stained Glass	⦿	BLK / SW / CP
	Estate	F-4980	10 1/2"	24"	--	--	--	Leaded Stained Glass	⦿	BLK / SW / CP
Tri-Light	Large	F-3980-TRI	22 1/4"	90 1/2"	--	--	--	Leaded Stained Glass	⦿	BLK / SW / CP

⦿ 2 Candelabra Base Bulbs  
⦿ Medium Base Bulb

See page 82 for ordering information and finish swatches

# ACCORD SERIES

The Accord Series incorporates clean lines and decorative seeded glass to provide an upscale look to an home or commercial property.

**Bottom Mount  
Wall Bracket**  
Shown in Copper (CP)





**Bottom Mount  
Wall Bracket**

Shown in  
Swedish Silver (SW)



**SHH-1006**

Complementing Wall Mount Mailbox  
See page 75 for details



**Tri-Light**

Shown in Copper (CP)

Style	Size	Item #	Width	Height	Ext.	T/O	Back Plate	Glass Choice	Light Source	Finish Choices
Bottom Mount	Medium	F-2887	9 1/2"	17"	11 1/2"	14 1/2"	4 1/2" W x 6 5/8" H	Clear Seedy	⦿	BLK / CP / SW
Tri-Light	Medium	F-2887-TRI-506	19"	83"	--	--	--	Clear Seedy	⦿	BLK / CP / SW

⦿ Medium Base Bulb

See page 82 for ordering information and finish swatches

# ASTOR SERIES

From the decorative arm scroll, to the detail on the fixture lid, the Astor Series is sure to provide years of enjoyment to any traditional style home.

**Bottom Mount  
Wall Bracket**  
Shown in Copper (CP)







**Tri-Light**  
Shown in Swedish Silver (SW)



**Post Mount**  
Shown in Swedish Silver (SW)



**Top Mount  
Wall Bracket**  
Shown in Copper (CP)



**SAP-4180**  
Complementing Address Plaque  
See page 79 for details

Style	Size	Item #	Width	Height	Ext.	T/O	Back Plate	Glass Choice	Light Source	Finish Choices
Top Mount	Medium	F-2961	9 1/4"	20 1/2"	10 1/2"	6 1/2"	4 1/2" W x 5 1/2" H	Beveled	⦿	BLK / SW / CP / ORB
	Large	F-3961	10"	22 3/4"	10 3/4"	4 3/4"	4" W x 7" H	Beveled	⦿	BLK / SW / CP / ORB
Bottom Mount	Medium	F-2967	9 1/4"	20 1/2"	10 1/2"	16"	4 1/2" W x 5 1/2" H	Beveled	⦿	BLK / SW / CP / ORB
	Large	F-3967	10"	22 3/4"	10 3/4"	18"	4" W x 7" H	Beveled	⦿	BLK / SW / CP / ORB
Post Mount	Medium	F-2960	9 1/4"	18"	--	--	--	Beveled	⦿	BLK / SW / CP / ORB
	Large	F-3960	10"	20 3/4"	--	--	--	Beveled	⦿	BLK / SW / CP / ORB
Tri-Light	Medium	F-2960-TRI-506	22 3/4"	84"	--	--	--	Beveled	⦿	BLK / SW / CP / ORB
	Large	F-3960-TRI-509	23 1/2"	114"	--	--	--	Beveled	⦿	BLK / SW / CP / ORB

⦿ Medium Base Bulb  
See page 82 for ordering information and finish swatches

# BRENTWOOD SERIES

The Brentwood Series incorporates transitional style with its two-toned glass lid and large back plate. These fixtures will provide an attractive addition to your home's exterior.

**Top Mount -  
Closed Bottom**  
Shown in Copper (CP)





**SAP-4360-100**  
Complementing Address Plaque  
See page 78 for details



**Top Mount -  
Open Bottom**  
Shown in Copper (CP)



**Bottom Mount  
Wall Bracket**  
Shown in Swedish Silver (SW)



**Post Mount**  
Shown in Black (BLK)

Style	Size	Item #	Width	Height	Ext.	T/O	Back Plate	Glass Choice	Light Source	Finish Choices
Top Mount-open bottom	Medium	F-2832	10 5/8"	17 11/16"	12 1/4"	4 3/4"	5 1/2" W x 15 1/4" H	Water Glass	⦿	BLK / SW / CP
	Large	F-3832	12 1/4"	20"	13 3/4"	4 3/4"	5 1/2" W x 15 1/4" H	Water Glass	⦿	BLK / SW / CP
Top Mount-closed bottom	Medium	F-2831	10 5/8"	19 11/16"	12 1/4"	4 3/4"	5 1/2" W x 15 1/4" H	Water Glass	⦿	BLK / SW / CP
	Large	F-3831	12 1/4"	23 1/2"	13 3/4"	4 3/4"	5 1/2" W x 15 1/4" H	Water Glass	⦿	BLK / SW / CP
Bottom Mount	Medium	F-2837	10 5/8"	20 1/2"	12 1/4"	16 1/2"	5 1/2" W x 15 1/4" H	Water Glass	⦿	BLK / SW / CP
	Large	F-3837	12 1/4"	22"	13 3/4"	18"	5 1/2" W x 15 1/4" H	Water Glass	⦿	BLK / SW / CP
Post Mount	Medium	F-2830	10 5/8"	19"	--	--	--	Water Glass	⦿	BLK / SW / CP
	Large	F-3830	12 1/4"	21"	--	--	--	Water Glass	⦿	BLK / SW / CP

⦿ Medium Base Bulb

See page 82 for ordering information and finish swatches

# CALDWELL SERIES

The Caldwell series incorporates traditional styling to create an elegant look. The rich details along with the clear glass globe highlighting candelabra type bulbs are sure to create a warm and inviting entrance to any home.



**Top Mount  
Wall Bracket**  
Shown in Black (BLK)



**Top Mount  
Wall Bracket**  
Shown in Swedish Silver (SW)





**Tri-Light**  
Shown in Copper (CP)



**SAP-4340-100**  
Complementing Address Plaque  
See page 78 for details



Style	Size	Item #	Width	Height	Ext.	T/O	Back Plate	Glass Choice	Light Source	Finish Choices
Top Mount	Medium	F-2891	5 1/2"	17"	9"	7 1/2"	4 3/4" W x 8" H	Clear		BLK / CP / SW
Tri-Light	Medium	F-2891-TRI-506	19"	83"	--	--	--	Clear		BLK / CP / SW

 2 Candelabra Base Bulb  
See page 82 for ordering information and finish swatches

# CLAREMONT SERIES

The Claremont Series recreates an old world look with a modern touch. From the graceful curved mounting arm to the criss-crossed accents the Claremont Series is sure to enhance the beauty of any home.



## **Medium Top Mount Wall Bracket**

Shown in Oil Rubbed Bronze (ORB)





**Large Top Mount  
Wall Bracket**  
Shown in Oil Rubbed Bronze (ORB)





**SAP-4180**  
Complementing Address Plaque  
See page 79 for details



**Post Mount**  
Shown in Oil Rubbed Bronze (ORB)

Style	Size	Item #	Width	Height	Ext.	T/O	Back Plate	Glass Choice	Light Source	Finish Choices
Top Mount	Medium	F-2861	8 1/2"	20 1/2"	10 3/4"	10"	4 1/2" W x 9" H	Clear Seedy		SW / CP / ORB
	Large	F-3861	10"	23 3/4"	12 1/2"	14 1/2"	5" W x 14" H	Clear Seedy		SW / CP / ORB
Post Mount	Medium	F-2860	8 1/2"	19 1/2"	--	--	--	Clear Seedy		SW / CP / ORB

 Medium Base Bulb  
 Cluster - 3 Candelabra Base Bulbs  
 See page 82 for ordering information and finish swatches

# FLORAL SERIES

The Floral Series has deeply embossed leaf designs that give these fixtures a charming appearance suitable for either a country or a suburban setting. The exquisite detail on this fixture adds to the charm of your home.

**Bottom Mount  
Wall Bracket - Short Tail**  
Shown in Verde Green (VG)







**Top Mount  
Wall Bracket**  
Shown in Copper (CP)



**Bottom Mount  
Wall Bracket -  
Long Tail**  
Shown in Verde Green (VG)



**Tri-Light**  
Shown in Copper (CP)



**SAP-4110**  
Complementing Address Plaque  
See page 79 for details



**Post Mount**  
Shown in Swedish Silver (SW)

Style	Size	Item #	Width	Height	Ext.	T/O	Back Plate	Glass Choice	Light Source	Finish Choices
Top Mount	Small	F-1941	8 1/4"	16 1/2"	9 1/2"	6"	4 1/4" W x 5 1/2" H	Beveled	💡	BLK / SW / CP / VG
	Medium	F-2941	10 1/2"	18"	10 1/2"	6"	4 1/4" W x 5 1/2" H	Beveled	💡	BLK / SW / CP / VG
Bottom Mount-short tail	Small	F-1947	8 1/4"	15"	9"	11"	4 1/4" W x 5 1/2" H	Beveled	💡	BLK / SW / CP / VG
	Medium	F-2947	10 1/2"	18 1/2"	10 1/2"	14"	4 1/4" W x 5 1/2" H	Beveled	💡	BLK / SW / CP / VG
	Large	3947	13"	24"	18"	17 3/4"	4 1/2" W x 5 3/4" H	Beveled	💡	BLK / SW / CP / VG
Bottom Mount-long tail	Small	F-1945	8 1/4"	19 3/4"	9 1/2"	10 1/2"	4 1/4" W x 5 1/2" H	Beveled	💡	BLK / SW / CP / VG
	Medium	F-2945	10 1/2"	25 1/2"	10 1/2"	14"	4 1/4" W x 5 1/2" H"	Beveled	💡	BLK / SW / CP / VG
	Large	3945	13"	33 1/2"	18"	17 3/4"	4 1/2" W x 5 3/4" H	Beveled	💡	BLK / SW / CP / VG
Post Mount	Medium	F-2940	10 1/2"	18 3/4"	--	--	--	Beveled	💡	BLK / SW / CP / VG
	Large	3940	13"	23 1/2"	--	--	--	Beveled	💡	BLK / SW / CP / VG
Tri-Light	Medium	F-2945-Tri-506	24"	84"	--	--	--	Beveled	💡	BLK / SW / CP / VG
	Large	3945-Tri-509	27"	114"	--	--	--	Beveled	💡	BLK / SW / CP / VG

💡 Medium Base Bulb

See page 82 for ordering information and finish swatches

# GLENN AIRE SERIES

Unequaled Elegance...What better way to describe the beauty and sophistication of the Glenn Aire Series. The clean lines and detailed lid will complement any style of architecture and provide a strong accent to any outdoor landscape.

**Bottom Mount  
Wall Bracket**  
Shown in Copper (CP)  
with Alabaster Glass





**Top Mount  
Wall Bracket**  
Shown in Black (BLK)  
with Alabaster Glass



**SAP-4360-100**  
Complementing Address Plaque  
See page 78 for details



**Post Mount**  
Shown in Swedish Silver (SW)  
with Alabaster Glass



**Tri-Light**  
Shown in Black (BLK)  
with Alabaster Glass

Series continued  
on next page

# GLENN AIRE SERIES





**Bottom Mount Wall Bracket**  
Shown in Copper (CP)  
with Clear Seedy Glass



**Top Mount Wall Bracket**  
Shown in Black (BLK)  
with Clear Seedy Glass



**Post Mount**  
Shown in Copper (CP)  
with Clear Seedy Glass



**SCB-1015**

Complementing Curbside Mailbox  
See page 46 for details

Style	Size	Item #	Width	Height	Ext.	T/O	Back Plate	Glass Choice	Light Source	Finish Choices
Top Mount	Medium	F-2991	10"	21 1/2"	12"	7 3/4"	5 1/4" W x 8" H	Alabaster / Clear Seedy	⦿	BLK / SW / CP / ORB
	Large	F-3991	11 3/4"	24 1/4"	13"	7 3/4"	5 1/2" x 8" H	Alabaster / Clear Seedy	⦿	BLK / SW / CP / ORB
Bottom Mount	Medium	F-2995	10"	28"	12"	13 1/4"	5 1/4" W x 8" H	Alabaster / Clear Seedy	⦿	BLK / SW / CP / ORB
	Large	F-3995	11 3/4"	31"	13"	16"	5 1/2" x 8" H	Alabaster / Clear Seedy	⦿	BLK / SW / CP / ORB
Post Mount	Medium	F-2990	10"	19 3/4"	--	--	--	Alabaster / Clear Seedy	⦿	BLK / SW / CP / ORB
	Large	F-3990	11 3/4"	23"	--	--	--	Alabaster / Clear Seedy	⦿	BLK / SW / CP / ORB
Tri-Light	Medium	F-2990-Tri-506	23 1/2"	84"	--	--	--	Alabaster / Clear Seedy	⦿	BLK / SW / CP / ORB
	Large	F-3990-Tri-509	25 1/4"	114"	--	--	--	Alabaster / Clear Seedy	⦿	BLK / SW / CP / ORB

⦿ Cluster - 3 Candelabra Base Bulbs  
See page 82 for ordering information and finish swatches

# PLANTATION SERIES

From the beveled glass top and sides, to the distinctive styling of the cage, you are sure to get a wealth of light from the Plantation Series.

**Bottom Mount  
Wall Bracket**  
Shown in Black (BLK)





**Top Mount Wall Bracket -  
Open Bottom**  
Shown in Black (BLK)

**Top Mount Wall Bracket -  
Closed Bottom**  
Shown in Black (BLK)

**Post Mount**  
Shown in Black (BLK)

Style	Size	Item #	Width	Height	Ext.	T/O	Back Plate	Glass Choice	Light Source	Finish Choices
Top Mount-open bottom	Medium	F-2952	9 1/2"	19"	11 1/2"	8 1/2"	4 3/4" W x 12 1/4" H	Beveled	☉	BLK
Top Mount-closed bottom	Medium	F-2951	9 1/2"	24"	11 1/2"	8 1/2"	4 3/4" W x 12 1/4" H	Beveled	☉	BLK
Bottom Mount	Medium	F-2957	9 1/2"	24"	11 1/2"	16 1/4"	4 3/4" W x 12 1/4" H	Beveled	☉☉☉	BLK
Post Mount	Medium	F-2950	9 1/2"	22"	--	--	--	Beveled	☉	BLK

☉ Medium Base Bulb

☉☉☉ Cluster - 3 Candelabra Base Bulbs

See page 82 for ordering information and finish swatches

# ROSE GARDEN SERIES

The Rose Garden Series, with its decorative cast aluminum overlay partially covering the glass lid, radiates a soft, welcoming glow. It will add the beauty of the Rose, a symbol of elegance and romance for centuries to the entrance of your home or garden.

## Top Mount Wall Bracket

Shown in Copper (CP)  
with Clear Seedy Glass







**Tri-Light**  
Shown in Copper (CP)  
with Clear Seedy Glass

**Bottom Mount  
Wall Bracket**  
Shown in Copper (CP)  
with Clear Seedy Glass



**Post Mount**  
Shown in Swedish Silver (SW)  
with Clear Seedy Glass



**SCB-1005**  
Complementing Mailbox  
See page 49 for details

**Series continued  
on next page**

# ROSE GARDEN SERIES



**Post Mount**  
Shown in Copper (CP)  
with Alabaster Glass



**Tri-Light**  
Shown in Copper (CP)  
with Alabaster Glass



**Top Mount  
Wall Bracket**  
Shown in Swedish Silver  
with Alabaster Glass

**Bottom Mount  
Wall Bracket**  
Shown in Oil Rubbed Bronze (ORB)  
with Alabaster Glass



**SHB-1004**  
Complementing  
Wall Mount Mailbox  
See page 74 for details



Style	Size	Item #	Width	Height	Ext.	T/O	Back Plate	Glass Choice	Light Source	Finish Choices
Top Mount	Small	F-1711	8 1/2"	16"	11 1/2"	6 3/8"	5 1/4" W x 8" H	Alabaster / Clear Seedy	⦿	BLK / SW / CP / ORB
	Medium	F-2711	10 1/2"	19 1/2"	12 3/4"	6 3/8"	5 1/4" W x 8" H	Alabaster / Clear Seedy	⦿	BLK / SW / CP / ORB
	Large	F-3711	12 3/4"	22 3/4"	14 3/4"	6 3/8"	5 1/4" W x 12" H	Alabaster / Clear Seedy	⦿	BLK / SW / CP / ORB
Bottom Mount	Small	F-1717	8 1/2"	16"	11 1/2"	9"	5 1/4" W x 8" H	Alabaster / Clear Seedy	⦿	BLK / SW / CP / ORB
	Medium	F-2717	10 1/2"	19 1/2"	12 3/4"	12 5/8"	5 1/4" W x 8" H	Alabaster / Clear Seedy	⦿	BLK / SW / CP / ORB
	Large	F-3717	12 3/4"	22 3/4"	14 3/4"	15 1/2"	5 1/4" W x 12" H	Alabaster / Clear Seedy	⦿	BLK / SW / CP / ORB
Post Mount	Medium	F-2710	10 1/2"	19"	--	--	--	Alabaster / Clear Seedy	⦿	BLK / SW / CP / ORB
	Large	F-3710	12 3/4"	22 1/2"	--	--	--	Alabaster / Clear Seedy	⦿	BLK / SW / CP / ORB
Tri-Light	Medium	F-2710-Tri-506	24"	88"	--	--	--	Alabaster / Clear Seedy	⦿	BLK / SW / CP / ORB
	Large	F-3710-Tri-509	26 3/4"	113"	--	--	--	Alabaster / Clear Seedy	⦿	BLK / SW / CP / ORB

⦿ Medium Base Bulb  
 ⦿ Cluster - 3 Candelabra Base Bulbs  
 See page 82 for ordering information and finish swatches

# SONOMA SERIES

The Sonoma Series, influenced by the beautiful southwestern style with clean lines that are complemented by unique water glass panels and an alabaster lid that will provide an impressive look to your home.

**Bottom Mount  
Wall Bracket**  
Shown in Copper (CP)

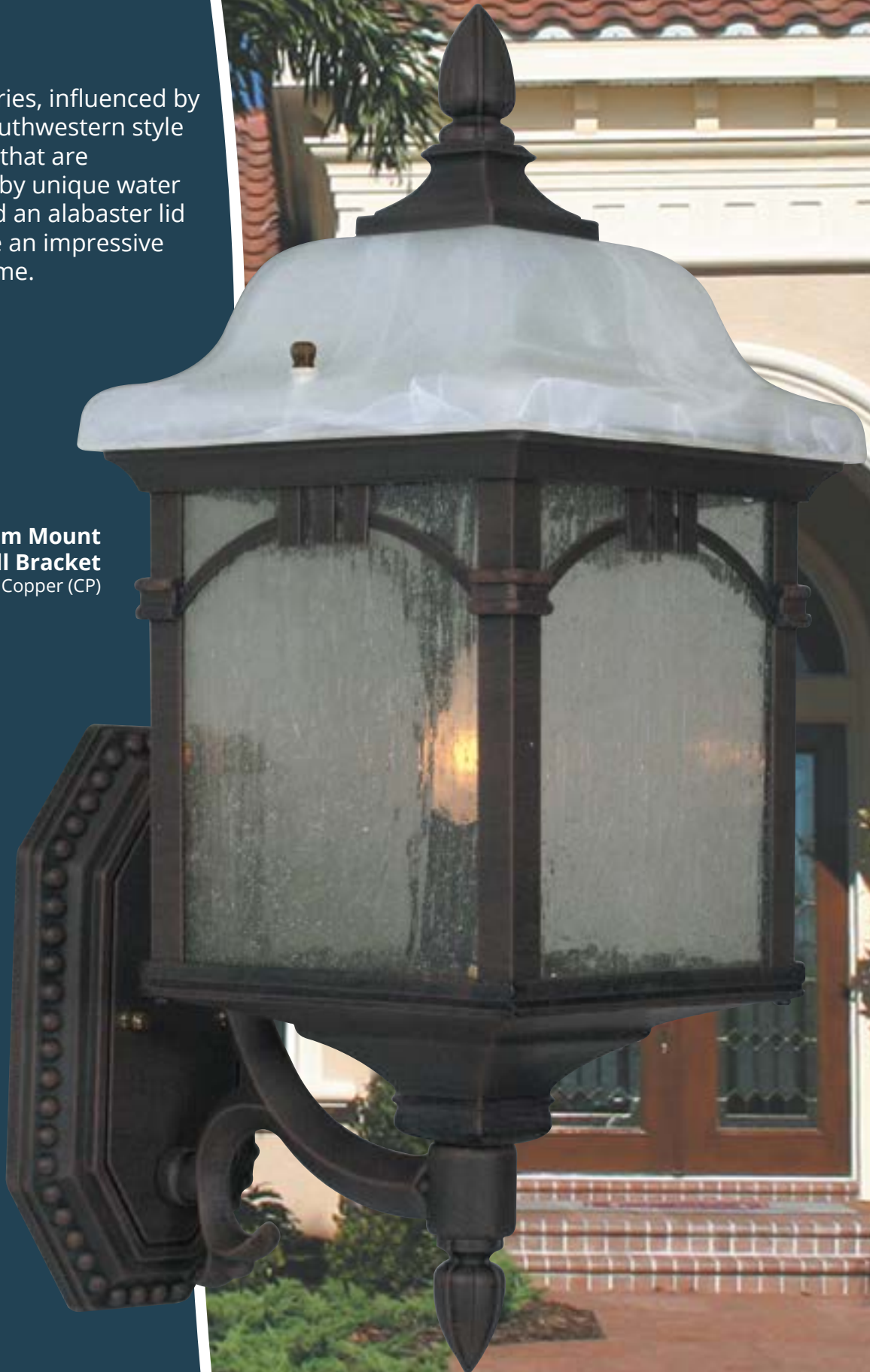



**Top Mount  
Wall Bracket**  
Shown in Copper (CP)



**Flush Mount**  
Shown in Copper (CP)



**Post Mount**  
Shown in Copper (CP)



**SAP-4220**  
Complementing  
Address Plaque  
See page 79 for details

Style	Size	Item #	Width	Height	Ext.	T/O	Back Plate	Glass Choice	Light Source	Finish Choices
Top Mount	Small	F-1751	7"	14"	10 1/2"	5"	4 3/4" W x 8 1/2" H	Water Glass	☉	BLK / CP / ORB
	Medium	F-2751	8"	15"	11"	6 3/4"	4 3/4" W x 8 1/2" H	Water Glass	☉	BLK / CP / ORB
	Large	F-3751	10"	19 3/8"	13 1/2"	13 3/16"	4 3/4" W x 8 1/2" H	Water Glass	☉	BLK / CP / ORB
Bottom Mount	Small	F-1757	7"	17 3/8"	10 7/16"	9 3/4"	4 3/4" W x 8 1/2" H	Water Glass	☉	BLK / CP / ORB
	Medium	F-2757	8"	19 1/2"	12"	12"	4 3/4" W x 8 1/2" H	Water Glass	☉	BLK / CP / ORB
	Large	F-3757	10"	22 3/4"	13 1/2"	12 1/2"	4 3/4" W x 8 1/2" H	Water Glass	☉	BLK / CP / ORB
Flush Mount	Medium	F-2753	10"	8"	--	--	--	Alabaster	☉	BLK / CP / ORB
Post Mount	Medium	F-2750	8"	19"	--	--	--	Water Glass	☉	BLK / CP / ORB
	Large	F-3750	10"	22 1/2"	--	--	--	Water Glass	☉	BLK / CP / ORB

☉ 2 Candelabra Base Bulbs

☉ Medium Base Bulb

☉ Cluster - 3 Candelabra Base Bulbs

See page 82 for ordering information and finish swatches

# VISTA SERIES

The modern look of the Vista Series with its fluted lid and sleek, curved arm provides the perfect look for any beach front or nautical style home.

**Top Mount  
Wall Bracket**  
Shown in Copper (CP)

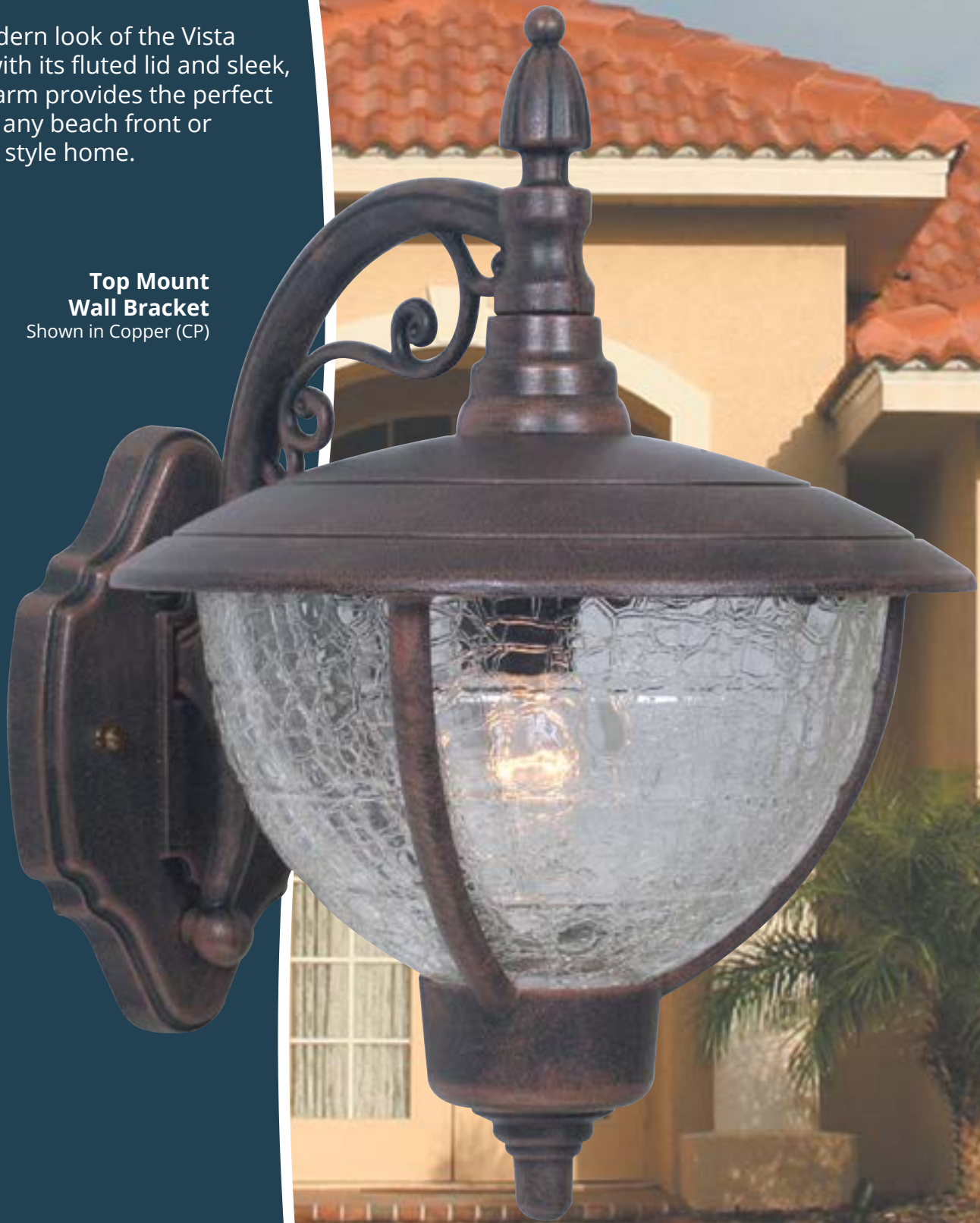



**Pro-Sin-FS-3FL-2-1010-0**  
 Complementing Sinclair  
 PRO-SERIES™ Mailbox System  
 See page 69 for details



**Tri-Light**  
 Shown in Black (BLK)



**Post Mount**  
 Shown in Black (BLK)

Style	Size	Item #	Width	Height	Ext.	T/O	Back Plate	Glass Choice	Light Source	Finish Choices
Top Mount	Medium	F-2911	10"	12 1/2"	12 1/2"	8 3/4"	4 3/4" W x 8" H	Crackled Globe	💡	BLK / SW / CP
Post Mount	Medium	F-2910	10"	8 3/4"	--	--	--	Crackled Globe	💡	BLK / SW / CP
Tri-Light	Medium	F-2910-Tri-506	23 1/2"	84"	--	--	--	Crackled Globe	💡	BLK / SW / CP

💡 Medium Base Bulb

See page 82 for ordering information and finish swatches

# DIRECT BURIAL LIGHT POSTS AND ACCESSORIES



**Dusk to Dawn  
Photo Electric  
Control  
PC-8010**  
120v Service.  
3/4" hole required.  
Finish Choice: BLK



**Post Electrical  
Outlet  
CO-268**  
Curved to fit a  
3" O/D round post.  
1 1/4" hole required.  
Finish Choice: BLK



**Stub Post Base  
SPB-190**  
(8" Tall x 10" Dia.)  
J-Bolts included



Model Number:	Post Length:
410 w/AD	10'
412 w/AD	12'
414 w/AD	14'
416 w/AD	16'

35" from the bottom of the access door to the bottom of the post.



Model Number:	Post Length:
MP-410 w/AD	10'
MP-412 w/AD	12'
MP-414 w/AD	14'
MP-416 w/AD	16'

35" from the bottom of the access door to the bottom of the post.



Model Number:	Post Length:
390	7'
408	8'
410	10'
412	12'
414	14'
416	16'



Model Number:	Post Length:
MP-407	7'
MP-408	8'
MP-410	10'
MP-412	12'
MP-414	14'
MP-416	16'



## 410 w/AD

Smooth Aluminum Post with Access Door  
10' Height  
3" O/D

## MP-410 w/AD

Fluted Aluminum Post with Access Door  
10' Height  
3" O/D

## 390

Smooth Aluminum Post  
7' Height  
3" O/D

## 400

Smooth Aluminum Post w/ Ladder Rest  
7' Height  
3" O/D

## MP-407

Fluted Aluminum Post  
7' Height  
3" O/D

## WRB1

Wrap Around Base For use w/ 3" O/D post only.  
26" Height x 8" Dia. Base

## WRB6

Wrap Around Base For use w/ 3" O/D post only.  
32" Height x 11 3/4" Dia. Base

See above for additional post length options.

Available in all finishes. See page 82 for options.



# SURFACE MOUNT LIGHT POSTS AND ACCESSORIES



SP-12 shown with SPB-170 base sold separately

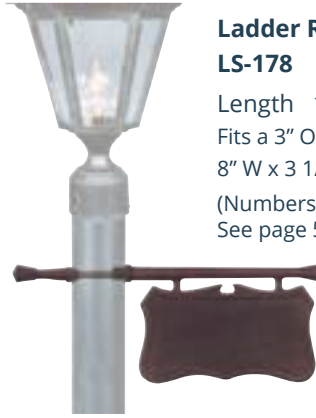

## Ladder Rest Sign

LS-178

Length 18" Height 6 1/2"

Fits a 3" O/D post with two 3/4" Dia. holes.

8" W x 3 1/2" H numbering area.

(Numbers not included -

See page 56 for number options)

## Stub Post (only)

Smooth aluminum post is available in the following lengths:

SP-12 measures 12"

SP-24 measures 24"

SP-36 measures 36"



## Stub Post Base SPB-170

Height 3 1/2"

Base 6 3/8" Wide

For use with 3" O/D post.



## Pedestal Base PB-173

Height 2 3/4"

Base 6" Wide

Fits directly into a post light bottom.



Surface mount posts are designed to accommodate all industry standard 3" O/D post lanterns. A mounting template and anchor bolts are included with all surface mount poles.

### 503

Cast Aluminum  
Height 42"  
Fluted Post  
10 1/4" Base

### 506

Cast Aluminum  
Height 72"  
Fluted Post  
10 1/4" Base

### 507

Cast Aluminum  
Height 90"  
Fluted Post  
10 1/4" Base

### 509

Cast Aluminum  
Height 99"  
Fluted Post  
10 1/4" Base

Available in all finishes. See page 82 for options.



**CURBSIDE  
MAILBOXES  
POSTS AND  
ACCESSORIES**

# CURBSIDE MAILBOXES

## Mailboxes with quality you can see.

Elegantly crafted cast aluminum residential mailboxes blend style, function, and durability. Rust free aluminum and a powder coated finish guarantee that these pieces will keep their beauty through years of use.

Curbside Mailboxes are offered with or without a paper tube. Coordinating accessories such as direct burial posts, surface mount posts and address plaques offer a variety of ways to mount these graceful pieces.

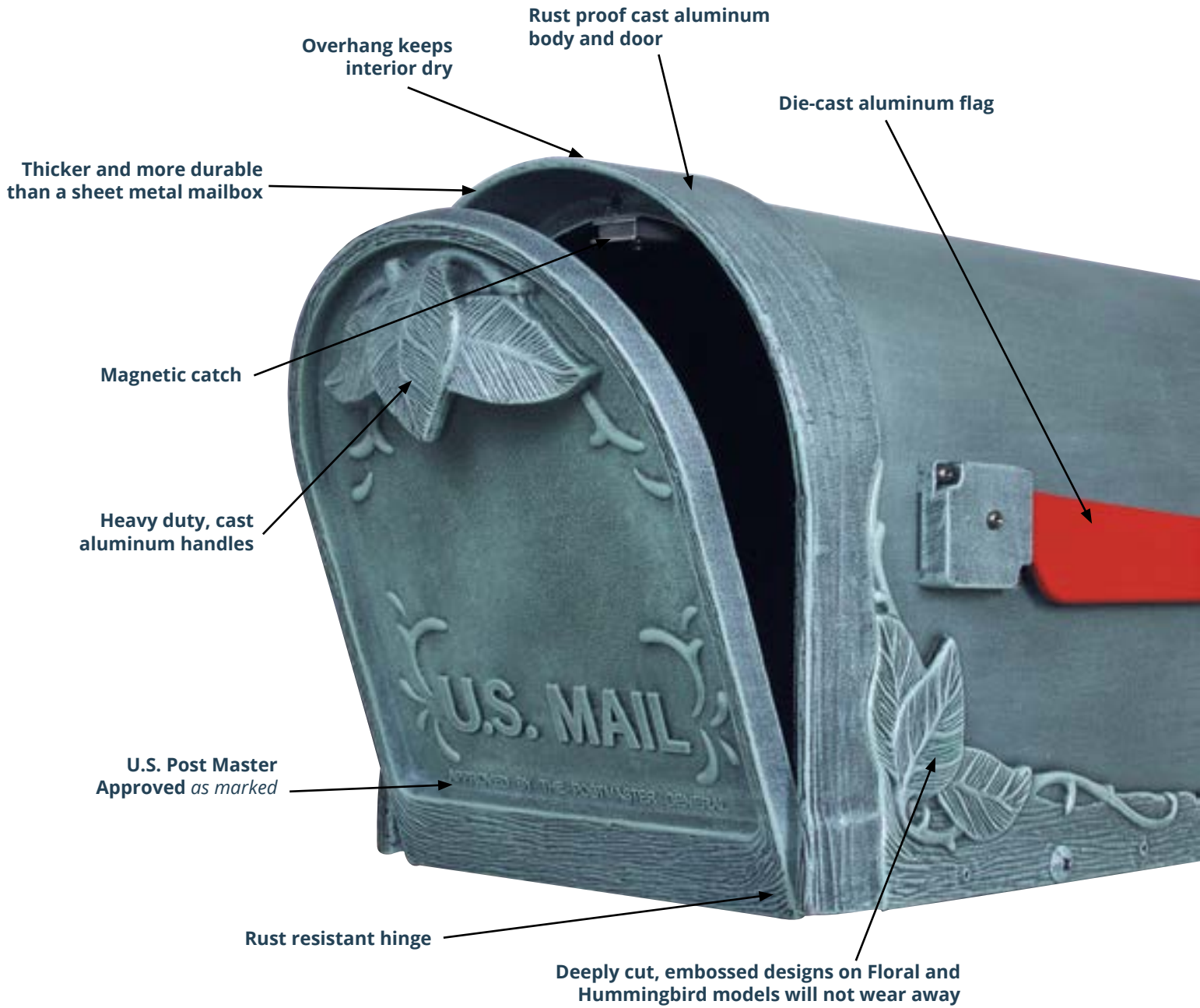

# FLORAL CURBSIDE MAILBOX

**Floral Curbside Mailbox with newspaper tube**  
**SCF-2003** Shown in Copper (CP)



**Complementing  
 Floral Light  
 Fixtures**  
 See pages 24 - 25  
 for details

**Floral  
 Curbside  
 Mailbox  
 SCF-1003**  
 Shown in  
 Verde Green (VG)  
 450 Post  
 sold separately

**Floral Curbside Two Door Mailbox**  
**SCF-1003-TD** Shown in Black (BLK)



The traditional mailbox shape gets a decorative upgrade with our Floral Curbside Mailbox. Deeply embossed leaf designs on all sides gives the Floral Curbside a charming appearance suitable for either a country or suburban home.

Description	Item #	Width	Height	Depth
Floral Curbside	SCF-1003	8 3/4"	10"	20"
Floral Curbside with Paper Tube	SCF-2003	8 3/4"	14 3/4"	20"
Floral Curbside with Two Doors	SCF-1003-TD	8 3/4"	10"	20"

See page 82 for finish options

# BERKSHIRE CURBSIDE MAILBOX



**Berkshire Curbside Mailbox  
SCB-1015**  
Shown in Black (BLK)



**Berkshire Curbside Mailbox  
with Newspaper Tube  
SCB-2015** Shown in Black (BLK)

**Berkshire  
Curbside Mailbox  
SCB-1015-DX**  
Shown in Copper (CP)  
*SPK-600 Post sold separately*

**LB-998**

Optional Lock Box Insert  
See page 57 for details



The Berkshire Curbside Mailbox presents an impressive face. The one piece cast aluminum door features deeply cut details with a rich, leather grain textured panel. The rust proof cast aluminum body construction creates a weather resistant mailbox and the stainless steel spring hinge and magnetic catch will keep the door secure.

Description	Item #	Width	Height	Depth
Berkshire Curbside	SCB-1015	9"	11 1/2"	19 3/4"
Berkshire Curbside with Paper Tube	SCB-2015	9"	14 1/4"	19 3/4"

See page 82 for finish options

# BERKSHIRE CURBSIDE MAILBOX

Customize your Berkshire Curbside Mailbox with one of the options shown below. Simply choose your option for address numbers, BR for Brass or SS for Stainless Steel, and we will affix the address numbers on your mailbox. Numbers and side panel are also available for self installation on other mailboxes and accessories (see page 56).

**How to Order:** To order a custom built Berkshire mailbox, follow the below guide for item numbers.



## Berkshire Curbside Mailbox with 2" Front Address Numbers.

Shown in Swedish Silver (SW) *Sample order number shown*

<b>SCB-1015-</b>	<b>FN-</b>	<b>BR-1234-</b>	<b>SW</b>
<i>Item Number</i>	<i>Front</i>	<i>Brass</i>	<i>Finish</i>
	<i>Numbers</i>	<i>Numbers</i>	

## Berkshire Curbside Mailbox with MP-454 side panels and 3" Numbers.

Shown in Mocha (MOC) *Sample order number shown*

<b>SCB-1015-</b>	<b>MP-</b>	<b>BR-7160-</b>	<b>MOC</b>
<i>Item Number</i>	<i>Mailbox Plaque</i>	<i>Brass</i>	<i>Finish</i>
	<i>Side Location</i>	<i>Numbers</i>	



## Combine both address options to mark your home clearly for first responders, deliveries, friends and family.

Shown in Black (BLK). *Sample order number shown*

<b>SCB-1015-</b>	<b>DX-</b>	<b>BR-3412-</b>	<b>BLK</b>
<i>Item Number</i>	<i>Front</i>	<i>Brass</i>	<i>Finish</i>
	<i>and Side</i>	<i>Numbers</i>	
	<i>Numbers</i>		

### How to Order:

To order a custom built Berkshire mailbox, follow the below guide for item numbers.

<b>1</b>	<b>SCB-1015-</b>	<b>FN / MP / DX-</b>	<b>SS or BR-#####-</b>	<b>MOC</b>
<i>QTY</i>	<i>Item Number</i>	<i>Address Number</i>	<i>Front / Side</i>	<i>Finish</i>
		<i>Location</i>	<i>Numbers</i>	
		<i>(Optional)</i>	<i>(Optional)</i>	

# CLASSIC CURBSIDE MAILBOX



**Classic Curbside Mailbox  
SCC-1008**

Shown in Black (BLK)

**Classic Curbside  
Two Door Mailbox  
SCC-1008-TD**

Shown in Mocha (MOC)



**Classic  
Curbside Mailbox  
SCC-1008**

Shown in Black (BLK)  
SPK-710, MP-453 and Brass  
Numbers sold separately



**Classic Curbside Mailbox  
with Newspaper Tube  
SCC-2008**

Shown in Black (BLK)

The traditional shape of our Classic Mailbox is the only thing this mailbox has in common with a typical curbside mailbox. The solid cast aluminum construction mailbox provides added strength, and the powder coated finish will maintain a lifetime of beauty.

Description	Item #	Width	Height	Depth
Classic Curbside	SCC-1008	8 3/4"	10"	20"
Classic Curbside with Paper Tube	SCC-2008	8 3/4"	14 3/4"	20"
Classic Curbside with Two Doors	SCC-1008-TD	8 3/4"	10"	20"

See page 82 for finish options



# HUMMINGBIRD CURBSIDE MAILBOX

**Hummingbird Curbside Mailbox  
with newspaper tube  
SCB-1005**

Shown in Swedish Silver (SW)



**Hummingbird Curbside Mailbox  
SCB-2005**

Shown in Copper (CP)



**Hummingbird Curbside Mailbox  
in Hand Painted Natural Finish  
SCB-1005-NAT**

**Hummingbird  
Curbside Mailbox  
SCB-1005**

Shown in Copper (CP)  
*SPK-600 Post sold separately*

The striking Hummingbird details on both sides of this mailbox make it more than your average mailbox. The deeply embossed designs show your love of nature and will last through a lifetime of weathering. This mailbox is also available in the unique hand painted "Natural" finish, in which the Hummingbird and each leaf are meticulously hand painted to bring out every detail.

Description	Item #	Width	Height	Depth
Hummingbird Curbside	SCB-1005	8 3/4"	10"	20"
Hummingbird Curbside with Paper Tube	SCB-2005	8 3/4"	14 3/4"	20"
Hummingbird Curbside in Natural Finish	SCB-1005-NAT	8 3/4"	10"	20"

See page 82 for finish options

# KINGSTON CURBSIDE MAILBOX



**Kingston Curbside Mailbox  
SCK-1017**  
Shown in Black (BLK)

**Kingston Curbside Mailbox with Newspaper Tube  
SCK-2017**  
Shown in Copper (CP)



**Kingston Curbside Mailbox  
SCK-1017**

Shown in Black (BLK)  
*SPK-679 Post sold separately*



**MP-455**  
Optional top mount address plaque  
See page 56 for details

The Kingston Curbside Mailbox will add a unique look to any homes curb appeal. The solid cast aluminum construction and geometric styling makes this mailbox the perfect choice for modern or contemporary architecture. No mounting plate required.

Description	Item #	Width	Height	Depth
Kingston Curbside	SCK-1017	9 1/4"	11 1/2"	20 1/4"
Kingston Curbside with Paper Tube	SCK-2017	9 1/4"	16 1/4"	20 1/4"

See page 82 for finish options

# SAVANNAH CURBSIDE MAILBOX

## Savannah Curbside Mailbox SCS-1014

Shown in Copper (CP)



## Savannah Curbside Mailbox with newspaper tube SCS-2014

Shown in Black (BLK)

## Savannah Curbside Mailbox SCS-1014

Shown in Copper (CP)  
SPK-600 Post sold separately

Combining quality and economy the Savannah Mailbox features a deeply cut, ornate cast aluminum door on a rolled aluminum body for maximum rust resistance. The Savannah's spring loaded roller door catch and powder coated base finish will not peel or fade in the elements for a lifetime of maintenance free use.

Description	Item #	Width	Height	Depth
Savannah Curbside	SCS-1014	9 1/2"	11 1/4"	21 3/4"
Savannah Curbside with Paper Tube	SCS-2014	9 1/2"	15 3/4"	21 3/4"

See page 82 for finish options

# STANDARD STEEL CURBSIDE MAILBOX



**Standard Steel Curbside Mailbox #1  
SCS-1018**

Shown in Smooth Glossy Black (SGB)



**Standard Steel Curbside Mailbox #1.5  
SCS-1019**

Shown in Smooth Glossy Black (SGB)

**Standard Steel  
Curbside Mailbox  
SCS-1018**

Shown in Black (BLK)  
SPK-710 Post  
sold separately

Standard Steel Mailboxes are available in two different sizes and constructed from galvanized steel. Rust resistant powder coated finish.

Description	Item #	Width	Height	Depth
Standard Steel Curbside #1	SCS-1018	7"	9"	20"
Standard Steel Curbside #1.5	SCS-1019	8 1/4"	10 3/4"	22 1/2"

See page 82 for finish options



**Titan Aluminum Curbside Mailbox  
SCH-1016A**

Shown in custom Forest Green Finish with white vinyl address and street name (see page 56 for vinyl details)



**Titan Steel Curbside Mailbox  
SCH-1016S**

Shown in Mocha (MOC)

**VANDAL RESISTANT MAILBOX**

Tired of replacing your mailbox because it is a target for baseball bats, rocks, and M-80's?

**The Titan Steel Mailbox is your solution.**

- Virtually Indestructible
- 3/32 (10 gauge) Thick Walls
- Fade Resistant, Powder Coated Finish

**Titan Curbside  
Mailbox  
SCH-1016A**

Shown in Black (BLK)  
*SPK-679 Post sold separately*

The Titan Aluminum and Titan Steel mailboxes are tough and durable mailboxes that are U.S. Postmaster General Approved and feature stainless steel hardware and hinge.

Description	Item #	Width	Height	Depth
Titan Aluminum Curbside	SCH-1016A	8 1/4"	10 1/2"	21 1/2"
Titan Aluminum Curbside with Paper Tube	SCH-2016A	8 1/4"	15"	21 1/2"
Titan Steel Curbside	SCH-1016S	8 1/4"	10 1/2"	21 1/2"
Titan Steel Curbside with Paper Tube	SCH-2016S	8 1/4"	15"	21 1/2"

See page 82 for finish options

# TOWN SQUARE CURBSIDE MAILBOX



**Town Square Curbside Mailbox  
STB-1007**  
Shown in Mocha (MOC)



**Town Square  
Curbside Mailbox  
with Newspaper Tube  
STB-2007**  
Shown in Copper (CP)

**Town Square  
Curbside Mailbox  
STB-1007**  
Shown in Copper (CP)  
*SPK-600 Post  
sold separately*



**LB-997**  
Optional Lock Box Insert  
See page 57 for details

Presenting a sleek and modern design, the Town Square Curbside Mailbox will complement both contemporary and traditional architecture perfectly. Combining modern design elements with classic styling, along with a brass handle and stainless steel hardware, the Town Square mailbox will enhance the curb-appeal of any home.

Description	Item #	Width	Height	Depth
Town Square Curbside	STB-1007	10 1/2"	10 3/4"	21"
Town Square Curbside with Paper Tube	STB-2007	10 1/2"	15 1/4"	21"

See page 82 for finish options

# TRADITIONAL CURBSIDE MAILBOX

## Traditional Curbside Mailbox SCT-1010

Shown in Black (BLK)



## Traditional Curbside Mailbox with Newspaper Tube SCT-2010

Shown in Swedish Silver (SW)

## Traditional Curbside Mailbox SCT-1010

Shown in Black (BLK)  
*SPK-700 Post sold separately*



### MP-453

Optional top mount address plaque  
See page 56 for details

Our Traditional Curbside Mailbox has universal appeal with its smooth geometric style, accented with a simple decorative braid. The low profile belies the spacious interior. No mounting plate is required.

Description	Item #	Width	Height	Depth
Traditional Curbside	SCT-1010	9"	11"	19 3/4"
Traditional Curbside with Paper Tube	SCT-2010	9"	16 1/2"	19 3/4"

See page 82 for finish options

# CURBSIDE ACCESSORIES

## Brass and Stainless Steel Address Numbers

Exterior grade 1/8" thick self adhesive address numbers are available in your choice of Stainless Steel and Polished Brass finish. To order, simply put your address after the item number and indicate the size of numbers you want. For example: If you want 2" Polished Brass numbers for address 1302, the item number you would use is **BR2-1302**.

- SS2** - Two Inch Stainless Steel Numbers
- SS3** - Three Inch Stainless Steel Numbers
- BR2** - Two Inch Polished Brass Numbers
- BR3** - Three Inch Polished Brass Numbers

1 2 3 4 5

**Stainless Steel Numbers**

6 7 8 9 0

**Brass Numbers**

## Vinyl Address Lettering

Add a unique and modern look to your mailbox by adding vinyl address numbers or address number and street name lettering. Reflective and non-reflective vinyl is available. 3" tall address numbers and 2" tall street name letters. Vinyl can be added to one side or both sides of most Special Lite mailboxes.

Available with the following mailbox finishes only:  
Smooth Glossy Black - White - Mocha - Oil Rubbed Bronze

Vinyl color options: White Reflective - Gold Reflective - White - Black

Font Choices: Times New Roman - **Clarendon** - **Myriad Pro**

*Please contact Special Lite or visit our website for a Vinyl Address Lettering Order Form.*



## Side Mounting Address Plaques

### MP-454 - Side Mounting Mailbox Plaque (set of two)

Add a sophisticated look to our Berkshire or Classic Curbside Mailboxes. The 12" W x 4" H screw on panels have a rich leather texture with a beveled edge, and accommodates up to five of our 3" numbers. A complete mounting kit is included. (Numbers sold separately, please see above).

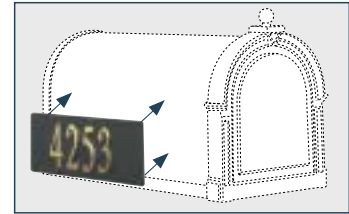

## Top Mounting Address Plaques



### MP-452

14 1/2" W x 3 1/2" H  
6 1/2" W x 2" H numbering area  
Shown in Copper (CP)

Fits all Special Lite Mailboxes except SCK-1017.



### MP-453

15 1/2" W x 3 1/2" H  
6 1/2" W x 2" H numbering area  
Shown in Swedish Silver (SW)

Fits all Special Lite Mailboxes except SCK-1017.



### MP-455

10 3/4" W x 4" H  
6 1/2" W x 2" H numbering area  
Shown in Copper (CP)

Fits all Special Lite Mailboxes.



## Floral Mounting Bracket



### MB-451

Width 6"  
Height 12"  
Length 12"  
Shown in Copper (CP)

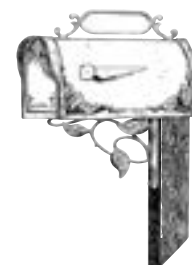



# LOCK BOX INSERTS - IDENTITY THEFT SOLUTIONS

## Protect yourself from the fastest growing crime in America:



**LB-998: Fits SCF-1003, SCB-1005, SCB-1015 and SCC-1008 Curbside Mailboxes**

Available in Black Finish Only

Last year, nearly 10 million people fell victim to **Identity Theft**. The FTC estimates it took each of them 14-16 months and over \$800 to clear their names.

Protect your credit card, bank account, and social security numbers from being stolen out of your mailbox with a Lock Box Insert.

Manufactured from rust free powder coated aluminum, the Lock Box Insert firmly attaches to the bottom of the mailbox and cannot be removed without the key.

The Lock Box Insert is easily installed with four screws (included).



**LB-997: Fits STB-1007 Town Square Mailbox**

Available in Black Finish Only



Open door view of LB-997

*Parcels up to one inch thick can pass through the slot into the safety of the Lock Box, while magazines and catalogs rest on the top of the Lock Box Insert.*

*An angled tab inside the slot prohibits anyone from reaching in and removing the mail.*



*Consult your local postmaster regarding regulations governing locking inserts.*

Item #	Fits Mailbox Numbers	Width	Height	Depth	Slot Size
LB-998	SCB-1015, SCF-1003, SCB-1005, and SCC-1008	6 5/8"	4 3/4"	18"	5 1/2" W x 1" H
LB-997	STB-1007 Town Square Mailbox	9"	6"	17"	6" W x 1" H

# SURFACE MOUNT / DIRECT BURIAL MAILBOX POSTS

## Ashland Series:

The Ashland Series offer two options for installation. It is provided with mounting hardware to attach to an existing concrete pad or a bolt-on 16" direct burial post for new installation into concrete.

**Ashland Double Post**  
**SPK-600-DBL**  
Shown in Black (BLK)



**Ashland Lighting and Mailbox Combination Post**  
**SPK-606**

May be used with any of our Post Mount Lanterns and Curbside Mailboxes. Shown in Copper (CP)



**Ashland Post**  
**SPK-600**  
Shown in Black (BLK)



Surface mount and direct burial options included for Ashland post only.

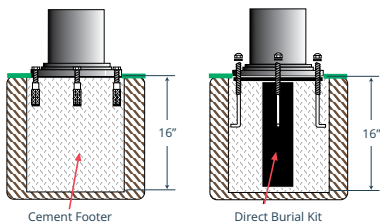

SPK-600-DBL with SCB-2015-FN mailboxes. (sold separately) Shown in Copper (CP)

Description	Item #	Height	Post Size
Ashland Mailbox Post	SPK-600	62"	7 1/2" Dia. Base
Ashland Double Mailbox Post	SPK-600-DBL	62"	7 1/2" Dia. Base
Ashland Combination Post	SPK-606	80 1/2"	7 1/2" Dia. Base

See page 82 for finish options

# SURFACE MOUNT / DIRECT BURIAL MAILBOX POSTS

## Tacoma Series:

The Tacoma Series Mailbox Post is a top mount, surface mount system. Available in top single and top double mount designs. A direct burial kit option is available, see descriptions below for proper model numbers.



**Tacoma Post  
SPK-591**  
Shown in  
Copper (CP)



SPK-591 with SCC-1008 mailbox. (sold separately)  
Shown in Copper (CP)



SPK-591-DBL with SCF-1003 (x2) mailboxes. (sold separately)  
Shown in Copper (CP)



**Tacoma Double Post  
SPK-592-DBL**  
Shown in Black (BLK)

Surface mount or direct burial options for the Tacoma post only.  
DB-101 Direct burial kit sold separately.

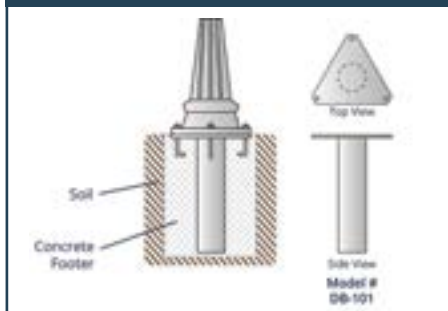

Description	Item #	Height	Post Size
Tacoma Mailbox Post	SPK-591	42"	9" Dia. Base
Tacoma Double Mailbox Post	SPK-591-DBL	42"	9" Dia. Base
Tacoma Triple Mailbox Post	SPK-591-TRI	42"	9" Dia. Base
Tacoma Mailbox Post with Direct Burial Kit	SPK-591-DB	42"	9" Dia. Base
Tacoma Double Mailbox Post with Direct Burial Kit	SPK-591-DB-DBL	42"	9" Dia. Base
Direct Burial Kit	DB-101	18"	9" Dia. Base

See page 82 for finish options

# DIRECT BURIAL MAILBOX POSTS

## Richland Series:

The Richland Series Mailbox Post is a 3" O/D fluted round post with decorative topper and mounting bracket. Available in single and double mount designs. Direct burial installation is required.



**Richland Post**  
**SPK-679**  
Shown in Black (BLK)

**Richland Double Post**  
**SPK-679-DBL**  
Shown in Black (BLK)

SPK-679  
with SCC-1008  
mailbox.  
*(sold separately)*  
Shown in  
Black (BLK)

**Albion Post**  
**SPK-651**  
Shown in Swedish  
Silver (SW)



SPK-651  
with SCF-1003  
mailbox.  
*(sold separately)*  
Shown in  
Swedish Silver  
(SW)

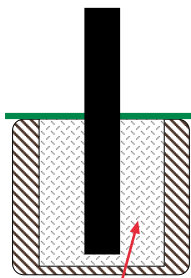

Cement Footer

## Albion Series:

The Albion Series Mailbox Post is a 3" O/D fluted round post with decorative topper and floral mounting bracket. Available in a single mount design. Direct burial installation is required.

Description	Item #	Height	Post Size
Richland Mailbox Post	SPK-679	72"	3" O/D
Richland Double Mailbox Post	SPK-679-DBL	72"	3" O/D
Albion Mailbox Post	SPK-651	72"	3" O/D

See page 82 for finish options

# DIRECT BURIAL MAILBOX POSTS

## Fresno Series:

The Fresno Series Mailbox Post features a 3" O/D fluted post and an adjustable arm that can accommodate any landscape condition. Direct burial installation is required.



**Fresno Post  
SPK-592**  
Shown in  
Black (BLK)



**Fresno  
Double Post  
SPK-592-DBL**  
Shown in Black (BLK)



Cement Footer



SPK-592  
with SCC-2008  
mailbox and  
MP-453 address  
plaque.  
(sold separately)

## Bradford Series:

The Bradford Series Mailbox Post is a top mount system with a 3" O/D smooth round post and base. Available in single and double mount designs. Direct burial installation is required.



SPK-590-DBL with SCC-1008  
mailboxes. (sold separately)  
Shown in Black (BLK)



**Bradford Post  
SPK-590**  
Shown in Black (BLK)



SPK-590 with  
SCC-1008  
mailbox.  
(sold separately)  
Shown in Copper (CP)

Description	Item #	Height	Post Size
Fresno Mailbox Post	SPK-592	72"	3" O/D Post with 8" Dia. Base
Fresno Double Mailbox Post	SPK-592-DBL	72"	3" O/D Post with 8" Dia. Base
Bradford Mailbox Post	SPK-590	58"	3" O/D Post with 8" Dia. Base
Bradford Double Mailbox Post	SPK-590-DBL	58"	3" O/D Post with 8" Dia. Base

See page 82 for finish options

# DIRECT BURIAL MAILBOX POSTS

## Edgewater Series:

The Edgewater Series Mailbox Post is a 3" O/D smooth round post with decorative topper and address plaque. Available in single and double mount designs. Direct burial installation is required.



## Monogram Post:

### SMP-550-(Insert Initial)

Cast aluminum post with a 4" initial on both sides in a black finish on a white background.



SMP-550-L with SCB-2015 mailbox. (sold separately)  
Shown in Copper (CP)



All initials available

## Floral Standard Post: 450

Decorative top mount mailbox post with cast aluminum scroll work.



450 with SCF-1003 mailbox. (sold separately)  
Shown in Verde Green (VG)

Description	Item #	Height	Post Size
Edgewater Mailbox Post	SPK-680	72"	3" O/D
Edgewater Double Mailbox Post	SPK-680-DBL	72"	3" O/D
Monogram Post	SMP-550-(Insert Initial)	58"	10 1/2" Width
Floral Standard Post	450	58"	10 1/2" Width

See page 82 for finish options

# DIRECT BURIAL MAILBOX POSTS

## Springfield Series:



The Springfield Series Mailbox Post is a 4" x 4" smooth aluminum square post with mounting bracket and topper. Direct burial installation.

## Main Street Series:

The Main Street Series Mailbox Post features a 4" x 4" square post with sculpted corners and accent flutes for an exclusive look. Direct burial installation.

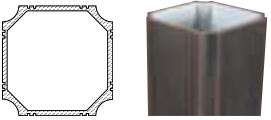

SPK-710 (white) with SCC-1008 mailbox with white vinyl lettering. (sold separately)

<p><b>Springfield Series Post Detail</b></p> 	<p><b>Optional WRB3 Base for Springfield &amp; Main Street Posts</b> Base sold separately. Dimensions: 7" x 7" x 14"</p> 
<p><b>Main Street Series Post Detail</b></p> 	

Description	Item #	Height	Post Size
Springfield Mailbox Post	SPK-710	72"	4" x 4" Smooth
Springfield Double Mailbox Post	SPK-710-DBL	72"	4" x 4" Smooth
Main Street Mailbox Post	SPK-700	72"	4" x 4" Fluted
Main Street Double Mailbox Post	SPK-700-DBL	72"	4" x 4" Fluted

See page 82 for finish options





# ADDITIONAL MAILBOXES

- PRO-SERIES™ MAILBOX SYSTEMS
- MULTI-UNIT MAILBOXES
- 4B AND 4C MAILBOX SYSTEMS
- CLUSTER BOX UNITS
- WALL MOUNT MAILBOXES

# PRO-SERIES™ MAILBOX SYSTEMS



PRO-SERIES™ mailbox systems are designed for the master plan community builder, developer, installer and property manager.

Whether working to complement an existing streetscape or seeking to create a “one of a kind” community aesthetic, the PRO-SERIES™ offers a wide range of styles, design choices and price options for curbside mailboxes.

PRO-SERIES™ mailbox systems are manufactured to your configuration. Engineered for ease of assembly and installation in the field, and bulk packaged for optimal shipping and handling.

## Minimum order quantities required for PRO-SERIES™ Mailbox Systems.

### Why choose the PRO-SERIES™?

#### Range of styles and options:

Choose from a multitude of mounting brackets, posts, toppers, mailboxes and bases to create a unique design. Single and double mailbox configurations available. See “how to configure” details on page 71.

#### Ease of installation:

Trouble-free components, minimized hardware and reduced packaging make installation straightforward and efficient for tradesman. See illustration to the right.

#### Lasting Value:

Replacement unit and re-ordering program options for add-ons, knockdowns and future phases...All supported by Special Lite’s experienced customer service team and 50+ years of producing quality products.

#### Project pricing:

Give us the details and let Special Lite work with you to develop a proposal specific to your customer’s needs and budget.

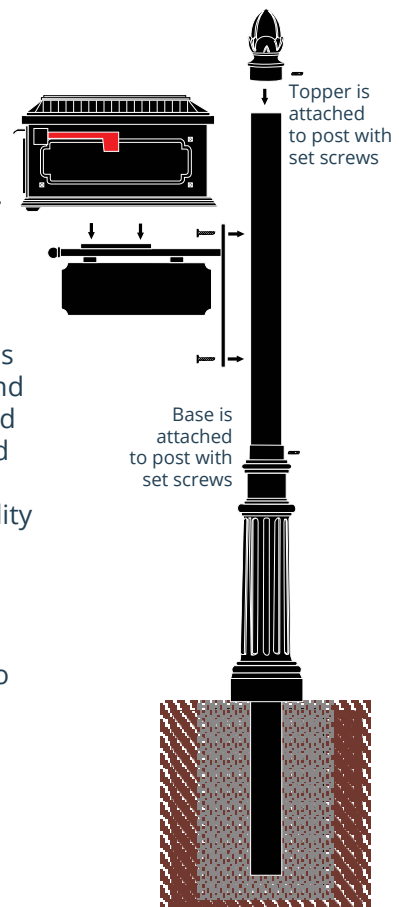

Contact Special Lite for additional product information, concept drawings and pricing.

## Ashley Curbside Mailbox System

The sleek and contemporary design of the Ashley mounting bracket will create a unique look that will enhance the curb appeal of any property. Choose from three mounting options.

Complete your Ashley mailbox system by building your configuration on page 71.

Bracket Detail

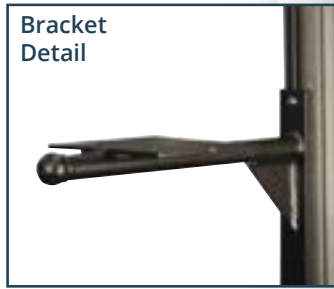

FRONT SINGLE (FS)

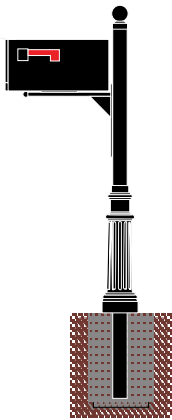

AS SHOWN  
Pro-Ash-FS-3SM-2-1018-5

SIDE SINGLE (SS)



AS SHOWN  
Pro-Ash-SS-3SM-4-1017-8

SIDE DOUBLE (SDBL)

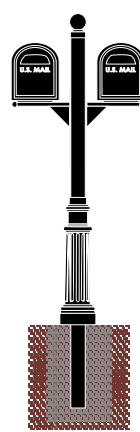

AS SHOWN  
Pro-Ash-SDBL-3SM-2-1008-5

## Atlantic Curbside Mailbox System

Classic styling best describes this popular curbside mailbox system, with its decorative mounting arm and large address plaque. Choose from three mounting options.

Complete your Atlantic mailbox system by building your configuration on page 71.

Bracket Detail



FRONT SINGLE (FS)

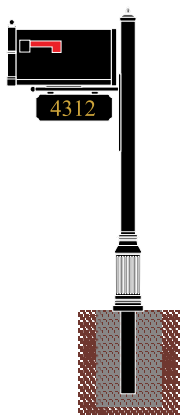

AS SHOWN  
Pro-Atl-FS-3SM-21-1015-17

SIDE SINGLE (SS)

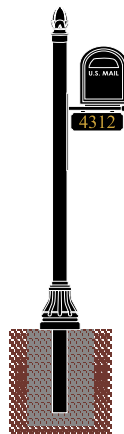

AS SHOWN  
Pro-Atl-SS-3SM-4-1008-8

SIDE DOUBLE (SDBL)

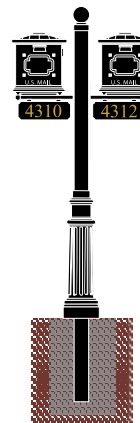

AS SHOWN  
Pro-Atl-SDBL-3SM-2-1017-5

# PRO-SERIES™ MAILBOX SYSTEMS



## Baldwin Curbside Mailbox System

The traditional design of the Ashley mounting bracket will create a unique look that will enhance the curb appeal of any property. Choose from three mounting options.

Complete your Baldwin mailbox system by building your configuration on page 71.



**FRONT SINGLE (FS)**

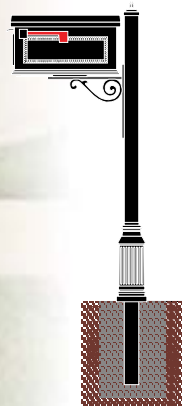

AS SHOWN  
Pro-Bwn-FS-3SM-21-1010-17

**SIDE SINGLE (SS)**

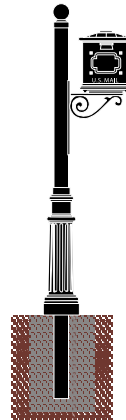

AS SHOWN  
Pro-Bwn-SS-3SM-2-1017-5

**SIDE DOUBLE (SDBL)**

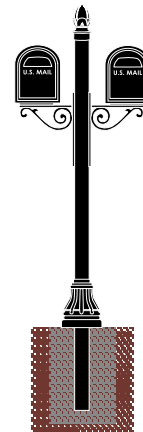

AS SHOWN  
Pro-Bwn-SDBL-3SM-4-1008-8



## Edgewood Curbside Mailbox System

The Edgewood curbside mailbox system features a decorative mounting arm with a contemporary address plaque that is made of 1/4" flat aluminum. Choose from three mounting options.

Complete your Edgewood mailbox system by building your configuration on page 71.



**FRONT SINGLE (FS)**

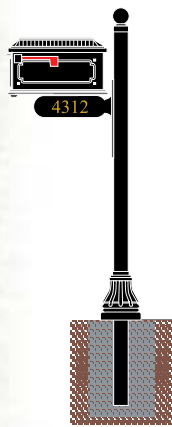

AS SHOWN  
Pro-Edg-FS-3SM-2-1017-8

**SIDE SINGLE (SS)**

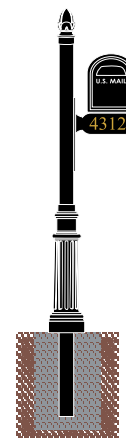

AS SHOWN  
Pro-Edg-SS-3SM-4-1008-5

**SIDE DOUBLE (SDBL)**

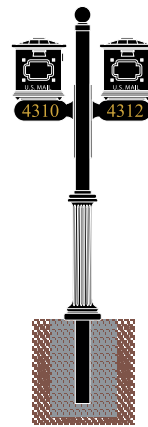

AS SHOWN  
Pro-Edg-SDBL-3SM-2-1017-1

## Hempfield Curbside Mailbox System

Answering the desire for luxurious suburban living, the Hempfield mailbox system offers a beautiful cast aluminum scroll. Available in front single and front double mounting options.

Complete your Hempfield mailbox system by building your configuration on page 71.

Bracket Detail



FRONT SINGLE (FS)

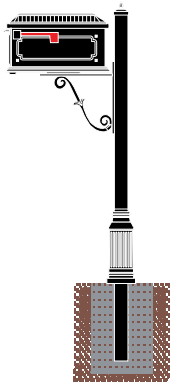

AS SHOWN  
Pro-Hem-FS-3SM-21-1017-17

FRONT DOUBLE (FDBL)

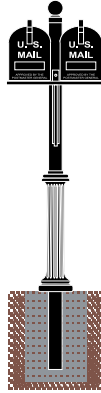

AS SHOWN  
Pro-Hem-FDBL-3SM-2-1018-1

## Sinclair Curbside Mailbox System

The Sinclair curbside mailbox mounting bracket has a deeply embossed, elegant scroll arm. Choose from four mounting options.

Complete your Sinclair mailbox system by building your configuration on page 71.

Bracket Detail

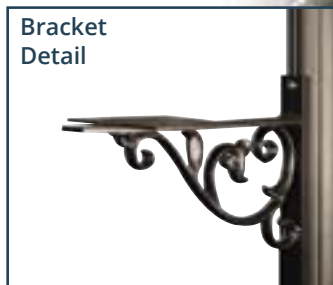

FRONT SINGLE (FS)

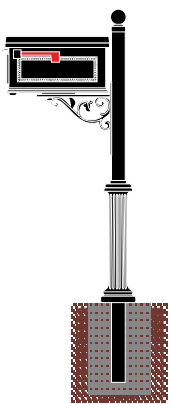

AS SHOWN  
Pro-Sin-FS-3SM-2-1010-1

FRONT DOUBLE (FDBL)

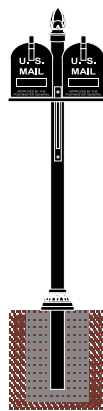

AS SHOWN  
Pro-Sin-FDBL-3SM-4-1018-7

SIDE SINGLE (SS)

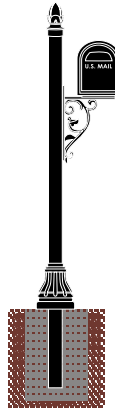

AS SHOWN  
Pro-Sin-SS-3SM-4-1008-8

SIDE DOUBLE (SDBL)

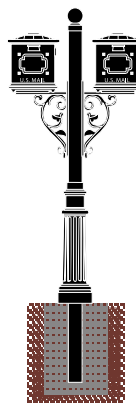

AS SHOWN  
Pro-Sin-SDBL-3SM-2-1017-5

## Sorrento Curbside Mailbox System

The elegant scroll arm of the Sorrento curbside mailbox system will provide a high class, decorative look to any home. Choose from four mounting options.

Complete your Sorrento mailbox system by building your configuration on page 71.

Bracket Detail



FRONT SINGLE (FS)    FRONT DOUBLE (FDBL)    SIDE SINGLE (SS)    SIDE DOUBLE (SDBL)

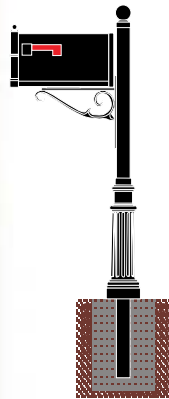

AS SHOWN

Pro-Sor-FS-3SM-2-1015-5



AS SHOWN

Pro-Sor-FDBL-3SM-5-1018-2

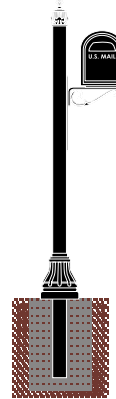

AS SHOWN

Pro-Sor-SS-3SM-17-1008-8

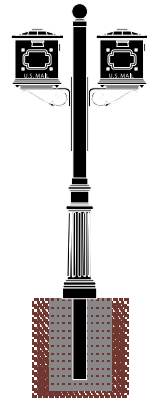

AS SHOWN

Pro-Sor-SDBL-3SM-2-1017-5

## Wingate Curbside Mailbox System

The contemporary design of the Wingate curbside mailbox system will provide an upscale look to any home. Choose from two mounting options.

Complete your Wingate mailbox system by building your configuration on page 71.

Bracket Detail



FRONT SINGLE (FS)

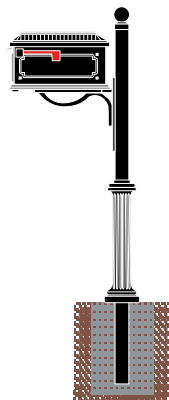

AS SHOWN

Pro-Win-FS-3SM-2-1017-1

FRONT DOUBLE (FDBL)

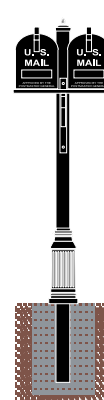

AS SHOWN

Pro-Win-FDBL-3SM-21-1018-17

# PRO-SERIES™ - HOW TO CONFIGURE

## STEP 1 - Select a Mounting Bracket

Choose a mounting bracket style. See pages 67 - 70 for mounting bracket images.

- Pro-Ash (Ashley) • Pro-Bwn (Baldwin) • Pro-Hem (Hempfield) • Pro-Sor (Sorrento)
- Pro-Atl (Atlantic) • Pro-Edg (Edgewood) • Pro-Sin (Sinclair) • Pro-Win (Wingate)

### How to Order Example:

Pro-Atlantic-FS - 3FL - 2 - 1017 - 5 - BLK  
Bracket Post Topper Mailbox Base Finish

**Minimum order required for PRO-SERIES™ Mailbox Systems.**

## STEP 2 - Select a Post



**3SM**  
3" O/D Smooth Post



**3FL**  
3" O/D Fluted Post



**4SM**  
4" O/D Smooth Post



**4FL**  
4" O/D Fluted Post



**4SQ**  
4" x 4" Smooth Square Post

## STEP 3 - Select a Post Topper

(For 3" Round Posts Only)



(For 4" Round Posts Only)



(For 4" x 4" Square Posts Only)



## STEP 4 - Select a Mailbox



**1007**  
Cast Aluminum Mailbox  
10 1/2" W x 10 3/4" H x 21" D



**1008**  
Cast Aluminum Mailbox  
8 3/4" W x 10" H x 20" D



**1010**  
Cast Aluminum Mailbox  
8 1/4" W x 9" H x 18" D



**1014**  
Rolled Aluminum Mailbox  
with Cast Aluminum Door  
9 1/2" W x 11 1/4" H x 21 3/4" D



**1015**  
Cast Aluminum Mailbox  
9" W x 10" H x 19 3/4" D



**1017**  
Cast Aluminum Mailbox  
9 1/2" W x 11 1/4" H x 20 3/4" D



**1018**  
Standard Steel Mailbox  
8 1/4" W x 9" H x 18" D

Newspaper tubes are available for each mailbox shown. To order a mailbox with a newspaper tube simply replace the first (1) in the model number with a (2).

For example:  
1007 becomes 2007

## STEP 5 - Select a Base (Optional)

(For 3" Round Posts Only)



(For 4" Round Posts Only)



(For 4" Square Posts Only)



## STEP 6 - Select a Finish

Choose from our selection of finish choices on page 82. Custom colors are available.

## STEP 7 - Select Address Numbers (Optional)

Available in your choice of self adhesive stainless steel, polished brass or reflective vinyl. 2" and 3" tall number sizes available. Durable and easy to apply.



### Address Number Options:

- VN2** - Two Inch Reflective Vinyl Numbers (White or Gold)
- VN3** - Three Inch Reflective Vinyl Numbers (White or Gold)
- SS2** - Two Inch Stainless Steel Numbers
- SS3** - Three Inch Stainless Steel Numbers
- BR2** - Two Inch Polished Brass Numbers
- BR3** - Three Inch Polished Brass Numbers

# MULTI-UNIT MAILBOXES



Enhance the curb appeal of a community or development in a cost effective way with multi-unit mailbox configurations comprised of our decorative posts and curbside mailboxes. Contact us today for additional information, design options and quotations.

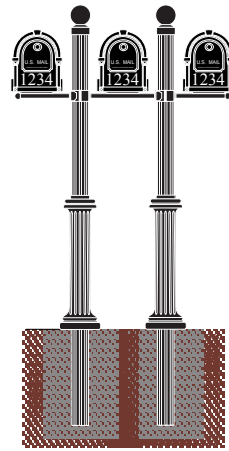

Example 1

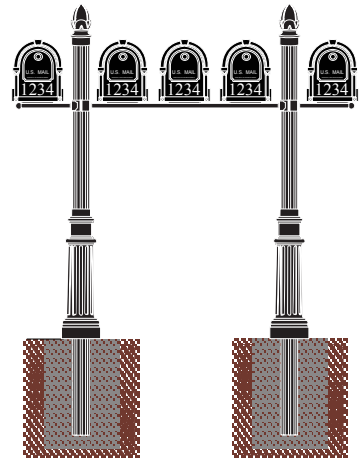

Example 2

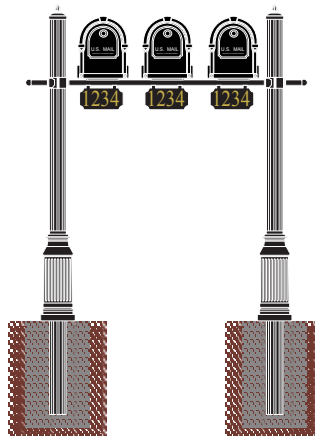

Example 3

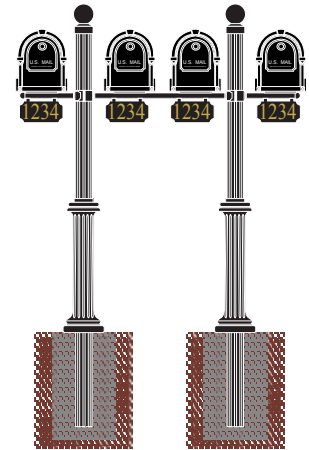

Example 4

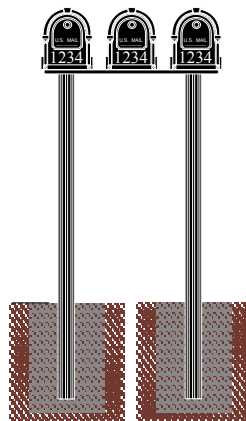

Example 5

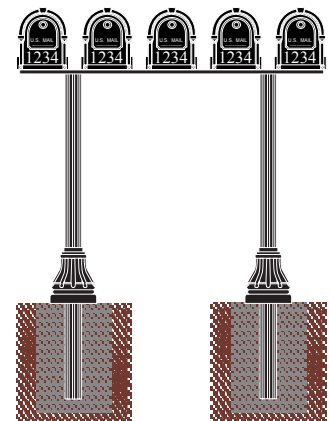

Example 6



# 4B, 4C MAILBOXES AND CLUSTER BOX UNITS

## 4B MAILBOXES

4B private distribution mailboxes are a favorite of university housing managers. These indoor solutions help keep mail areas organized. Available in front-loading or rear-loading units.

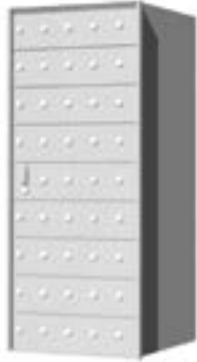

160095A



160086A

## 4C MAILBOXES

4C surface mount mailboxes are designed for indoor or outdoor use. Heavy-duty mailbox enclosures allow 4C modules to quickly and easily be mounted to any flat surface.



4C07D-06AB



4C13D-07AB

## CLUSTER BOX UNITS

The most popular centralized mail delivery equipment for residential neighborhoods is the freestanding, pedestal-mounted Cluster Box Unit (CBU).

Whether a neighborhood has aging mailboxes or if a municipality is requiring a new development to use a centralized mail location, using secure and convenient cluster box units may be the solution.

Contact Special Lite for additional product information, concept drawings and pricing.



1570-13



1570-12V



1570-8V2



Looking to turn a standard CBU into something more "upscale"? We have many attractive accessories available.



# WALL MOUNT MAILBOXES



**Contemporary  
Vertical Mailbox  
SVC-1002**  
Shown in Black (BLK)  
Scrolls included



**Contemporary  
Horizontal Mailbox  
SHC-1002**  
Shown in Black (BLK)  
Scrolls included



**Hummingbird Horizontal Mailbox  
SHB-1004**  
Shown in Copper (CP)  
Scrolls included



**Hummingbird  
Horizontal Mailbox  
SHB-1004-NAT**  
Shown in Hand Painted  
Natural Finish (NAT)  
Scrolls included

Description	Item #	Width	Height	Ext.
Contemporary Horizontal	SHC-1002	17"	12 3/4"	5"
Contemporary Vertical	SVC-1002	8 5/8"	16 5/8"	3 1/4"
Hummingbird Horizontal	SHB-1004	17"	12 3/4"	5"
Hummingbird - Natural Finish	SHB-1004-NAT	17"	12 3/4"	5"

See page 82 for finish options

# WALL MOUNT MAILBOXES



**Floral  
Vertical Mailbox  
SVF-1001**  
Shown in Verde Green (VG)  
Scrolls included

**Floral  
Horizontal Mailbox  
SHF-1001**  
Shown in Verde Green (VG)  
Scrolls included



**Horizon  
Horizontal Mailbox  
SHH-1006**  
Shown in Copper (CP)  
Scrolls included

**Victoria  
Vertical Mailbox  
SVV-1013**  
Shown in Copper (CP)  
Scrolls included



Description	Item #	Width	Height	Ext.
Floral Vertical	SVF-1001	9 1/4"	16 1/2"	3"
Floral Horizontal	SHF-1001	17"	12 3/4"	5"
Horizon Horizontal	SHH-1006	16"	8 1/4"	3 3/4"
Victoria Vertical	SVV-1013	13"	17 1/2"	4"

See page 82 for finish options



# ADDRESS PLAQUES AND SITE FURNISHINGS

# ADDRESS PLAQUES

## Cast Aluminum Address Plaques

Solid cast aluminum address plaques with black finish and permanently molded 3" tall brushed aluminum numbers.



**SAP-4360-100**  
5 1/2" W x 17 1/4" H  
Bold italic font  
Maximum four numbers



**SAP-4360-101**  
5 1/2" W x 17 1/4" H  
Times font  
Maximum four numbers



**SAP-4370-100**  
5 1/2" W x 17 1/4" H  
Bold italic font  
Maximum four numbers



**SAP-4370-101**  
5 1/2" W x 17 1/4" H  
Times font  
Maximum four numbers



**SAP-4380-100**  
5 1/2" W x 20 1/4" H  
Bold italic font  
Maximum five numbers



**SAP-4380-101**  
5 1/2" W x 20 1/4" H  
Times font  
Maximum five numbers



**SAP-4390-100**  
5 1/2" W x 20 1/4" H  
Bold italic font  
Maximum five numbers



**SAP-4390-101**  
5 1/2" W x 20 1/4" H  
Times font  
Maximum five numbers



**SAP-4320-100**  
11 1/2" W x 9" H  
Bold italic font  
Maximum four numbers



**SAP-4320-101**  
11 1/2" W x 9" H  
Times font  
Maximum four numbers



**SAP-4330-100**  
10 1/2" W x 6 1/2" H  
Bold italic font  
Maximum three numbers



**SAP-4330-101**  
10 1/2" W x 6 1/2" H  
Times font  
Maximum three numbers



**SAP-4340-100**  
11 3/4" W x 6" H  
Bold italic font  
Maximum three numbers



**SAP-4340-101**  
11 3/4" W x 6" H  
Times font  
Maximum three numbers



**SAP-4350-100**  
12 3/4" W x 9 1/2" H  
Bold italic font  
Maximum four numbers



**SAP-4350-101**  
12 3/4" W x 9 1/2" H  
Times font  
Maximum four numbers

## Home Address Plaques

Our line of address plaques help mark any home with a unique style. Solid cast aluminum and powder coated to withstand the elements. These beautiful plaques coordinate with our residential lighting line.

*(Up to five 3" numbers in your choice of Polished Brass or Stainless Steel are supplied at time of order).*

See page 82 for finish swatches



**SAP-4110**  
14" W x 10 1/2" H  
Available in all finishes with White Background.



**SAP-4180**  
14" W x 10 1/2" H  
Available in all finishes with White Background.

## Lighted Address Plaques

Give your home the mark of distinction with a bright and durable Lighted Address Plaque. Visible at over 100 feet away, Low Voltage Address Plaques are made from Cast Aluminum or Rigid Polymer. These plaques can be wired directly to your door bell transformer or plugged directly into a wall outlet with the optional Wall Outlet Transformer. Ten feet of low voltage wire is included. Choose up to five 4 inch black numbers per Lighted Address Plaque at the time of order.



**SAP-4210** (cast aluminum)  
14 1/2" W x 10 3/8" H  
12 Volt  
Available in all finishes with White Background.



**SAP-4220** (cast aluminum)  
13 3/4" W x 8 7/8" H  
12 Volt  
Available in all finishes with White Background.

See page 82 for finish swatches

**SAP-4230** (rigid polymer)  
13 3/4" W x 8 7/8" H  
12 Volt  
Available in Black finish with White Background.



## Lighted Address Plaque Accessories



**DBT-4200**  
Door Bell Transformer  
12 Volt

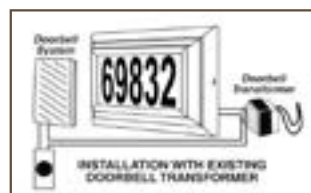

**WOT-4200**  
Wall Outlet Transformer

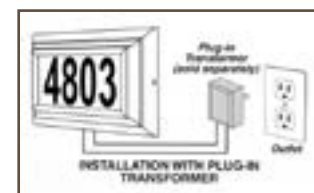

# SITE FURNISHINGS

## Bollards

Bollards can be used at key locations to create a sense of separation between pedestrian and vehicular areas and to add visual interest to a streetscape. Bollards are built standard without chain loops. Please specify if chain loops are required. Contact us today for additional information, design options and quotations.

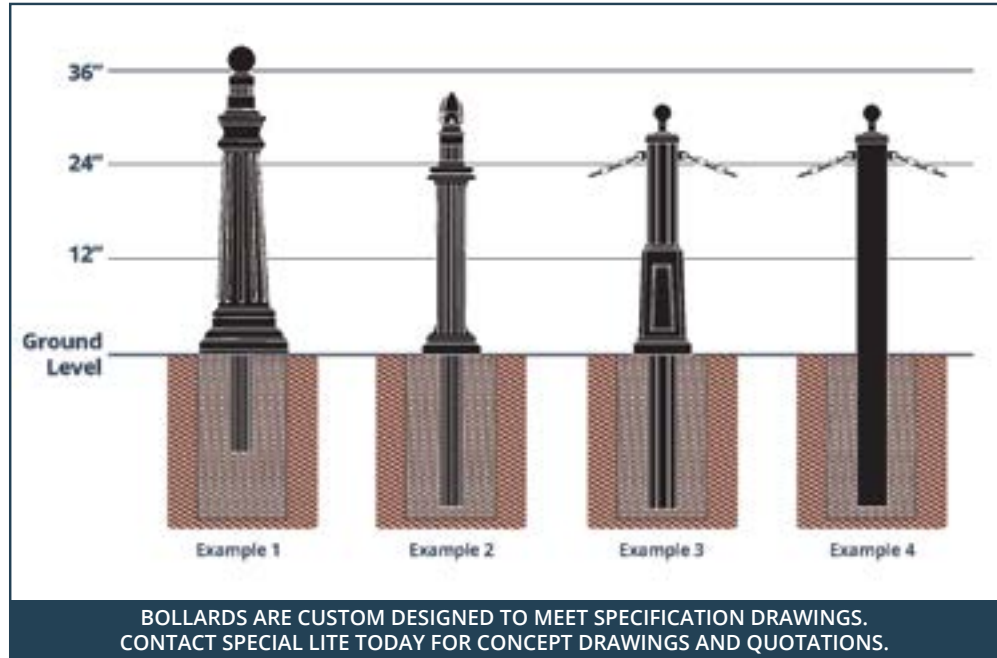

CRASH TESTS: We have not conducted nor do we intend to conduct a laboratory crash test. We do not boast or claim that given bollards will withstand any given force or impact for liability purposes. Bollards are designed as a deterrent and precautionary boundary only.

## Pet Waste Stations

Dog waste management is a major challenge when trying to keep common areas clean and green. Our pet waste stations offer a complete and attractive solution that can be coordinated with community signage and mailboxes.

- Extruded and cast aluminum construction that will not rust
- Available in textured black and evergreen powder coated finishes
- Decorative pole and topper
- Stainless steel hardware
- Logo and sponsorship signage options
- Refill bags and liners available



**PS-700**  
(Shown in Evergreen)



**PS-701**  
(Shown in Black)



**PS-802**  
(Shown in Black)



## Message Boards / Letter Boards

Decorative message board / letter board assemblies are perfect for home owner associations, apartment complexes or universities. Our enclosed, weather resistant message board systems come standard with a decorative hood that provides protection from the elements. Decorative message boards can be coordinated with your traffic poles and and/or mailboxes to create a unified look throughout a property. Contact us today for additional information, design options and quotations.

- single post or a double post mounting options
- Rust free aluminum construction

- Lockable doors with keys
- Durable acrylic window(s)



# ORDERING INFORMATION AND FINISH OPTIONS

## LIGHT FIXTURE ORDERING INSTRUCTIONS

PLACE YOUR ORDER IN THE FOLLOWING SEQUENCE:

1. Quantity
2. Complete Model Number
3. Desired Finish Code
4. Desired Glass Code
5. Light Source (if applicable)
6. Tri-Light (if applicable)

2 3025 BLK BV ST TRI

H = Height  
W = Width  
Ext. = Extension  
T/O = Top of the fixture H to the center of the outlet

## MAILBOX ORDERING INSTRUCTIONS\*

PLACE YOUR ORDER IN THE FOLLOWING SEQUENCE:

1. Quantity
2. Complete Model Number
3. Desired Finish Code

2 SCC-1008 BLK

FINISHES  
All items are available in all finishes

**\*DOES NOT APPLY TO PRO-SERIES™**

H = Height  
W = Width  
D = Depth

## FINISH OPTIONS

Features a premium quality thermoset polyester powdercoat for a durable finish. Copper, Swedish Silver and Verde Green include a hand brushed antique application.

All finish options below are available for mailboxes, street and area lighting & site furnishings. For residential lighting finish choices refer to each individual lighting family for details.



Textured Black (BLK)



Copper (CP)



Mocha (MOC)



Oil Rubbed Bronze (ORB)



Smooth Glossy Black (SGB)



Swedish Silver (SW)



Verde Green (VG)



White (WH)

*Custom finishes are available. Please contact us for pricing and availability.*

<b>Item Number</b>	<b>Page Number</b>	<b>Item Number</b>	<b>Page Number</b>
390 .....	40	F-1711 .....	32, 35
400 .....	40	F-1717 .....	33, 35
408 .....	40	F-1751 .....	37
410 .....	40	F-1757 .....	36
410w/AD .....	8, 40	F-1941 .....	25
412 .....	40	F-1945 .....	25
412w/AD .....	8, 40	F-1947 .....	24
414 .....	40	F-2710 .....	33, 34
414w/AD .....	8, 40	F-2710-Tri-506 .....	33, 35
416 .....	40	F-2711 .....	32, 35
416w/AD .....	8, 40	F-2717 .....	33, 35
450 .....	62	F-2750 .....	37
503 .....	41	F-2751 .....	37
506 .....	41	F-2753 .....	13, 37
507 .....	41	F-2757 .....	36
509 .....	41	F-2830 .....	19
608 .....	8	F-2831 .....	18
608w/AD .....	8	F-2832 .....	19
610 .....	8	F-2837 .....	19
610w/AD .....	8	F-2860 .....	23
612 .....	8	F-2861 .....	22
612w/AD .....	8	F-2870 .....	6
614 .....	8	F-2887 .....	14, 15
614w/AD .....	8	F-2887-TRI-506 .....	15
616 .....	8	F-2891 .....	20, 21
616w/AD .....	8	F-2891-TRI-506 .....	21
2790-AC3010 .....	6	F-2910 .....	39
2790-AC3012 .....	6	F-2911 .....	38
2797-AC3010 .....	6	F-2910-Tri-506 .....	39
2797-AC3012 .....	6	F-2940 .....	17
2810-PC1016CL .....	6	F-2941 .....	25
2817-PC1016CL .....	6	F-2945 .....	25
3940 .....	25	F-2945-Tri-506 .....	25
3945 .....	25	F-2947 .....	24
3945-Tri-509 .....	25	F-2950 .....	31
3947 .....	24	F-2951 .....	31
AC-1026CL-Type III .....	9	F-2952 .....	31
AC-1026CL-Type V .....	9	F-2957 .....	30
B-127-E26 .....	7	F-2960 .....	17
B-130-E26 .....	7	F-2960-Tri-506 .....	17
B-135-E26 .....	7	F-2961 .....	17
B-140-E26 .....	7	F-2967 .....	16
B-145-E26 .....	7	F-2980 .....	13
B-153-E26 .....	7	F-2987 .....	12
BR2 .....	56	F-2990 .....	27, 29
BR3 .....	56	F-2990-Tri-506 .....	27
CO-268 .....	9, 40	F-2991 .....	27, 29
DB-101 .....	59	F-2995 .....	26, 29
DBT-4200 .....	79	F-3710 .....	33, 34
DSR-360-MED .....	9	F-3710-Tri-509 .....	33, 35
DSR-360-MOG .....	9	F-3711 .....	32, 35

# INDEX

<b>Item Number</b>	<b>Page Number</b>	<b>Item Number</b>	<b>Page Number</b>
F-3717 .....	33, 35	PC-8010 .....	9, 40
F-3750 .....	37	PC-8015 .....	9
F-3751 .....	37	PFIN .....	9
F-3757 .....	36	PS-700 .....	80
F-3830 .....	19	PS-701 .....	80
F-3831 .....	18	PS-802 .....	80
F-3832 .....	19	PSM-408w/AD.....	8
F-3837 .....	19	PSM-410w/AD.....	8
F-3861 .....	23	PSM-412w/AD.....	8
F-3960 .....	17	PSM-MP-408-w/AD.....	8
F-3960-Tri-509 .....	17	PSM-MP-410-w/AD.....	8
F-3961 .....	17	PSM-MP-412-w/AD.....	8
F-3967 .....	16	PSM-608w/AD.....	8
F-3980 .....	13	PSM-610w/AD.....	8
F-3980-Tri .....	13	PSM-612w/AD.....	8
F-3987 .....	12	PSM-614w/AD.....	8
F-3990 .....	27, 29	PSM-MP-608-w/AD.....	8
F-3990-Tri-509 .....	27	PSM-MP-610-w/AD.....	8
F-3991 .....	27, 29	PSM-MP-612-w/AD.....	8
F-3995 .....	26, 29	PSM-MP-614-w/AD.....	8
F-4980 .....	13	PRO-SERIES .....	66
F-4987 .....	12	PRO-ASH .....	67
Finish Options .....	82	PRO-ATL .....	67
HSS-90 .....	9	PRO-BWN .....	68
HSS-180 .....	9	PRO-EDG .....	68
LB-997 .....	57	PRO-HEM .....	69
LB-998 .....	57	PRO-SIN .....	69
LS-178 .....	41	PRO-SOR .....	70
MB-451 .....	56	PRO-WIN .....	70
MOG-ADPT .....	7	SAP-4110 .....	79
MP-407 .....	40	SAP-4180 .....	79
MP-408 .....	40	SAP-4210 .....	79
MP-410 .....	40	SAP-4220 .....	79
MP-410 w/AD .....	8, 40	SAP-4230 .....	79
MP-412 .....	40	SAP-4320-100 .....	78
MP-412 w/AD .....	8, 40	SAP-4320-101 .....	78
MP-414 .....	40	SAP-4330-100 .....	78
MP-414 w/AD .....	8, 40	SAP-4330-101 .....	78
MP-416 .....	40	SAP-4340-100 .....	78
MP-416 w/AD .....	8, 40	SAP-4340-101 .....	78
MP-452 .....	56	SAP-4350-100 .....	78
MP-453 .....	56	SAP-4350-101 .....	78
MP-454 .....	56	SAP-4360-100 .....	78
MP-455 .....	56	SAP-4360-101 .....	78
MP-608 .....	40	SAP-4370-100 .....	78
MP-608 w/AD .....	40	SAP-4370-101 .....	78
P7327 .....	9	SAP-4380-100 .....	78
PB-173 .....	41	SAP-4380-101 .....	78
PC-1016CL .....	9	SAP-4390-100 .....	78
PC-1023CL .....	9	SAP-4390-101 .....	78
PC-1026CL .....	9	SCB-1005 .....	49
PC-2020CL .....	9	SCB-1005-NAT .....	49

<b>Item Number</b>	<b>Page Number</b>	<b>Item Number</b>	<b>Page Number</b>
SCB-2005 .....	49	SPK-679 .....	60
SCB-1015.....	46,47	SPK-679-DBL .....	60
SCB-2015 .....	46	SPK-680 .....	62
SCC-1008 .....	48	SPK-680-DBL .....	62
SCC-1008-TD .....	48	SPK-700 .....	63
SCC-2008 .....	48	SPK-700-DBL .....	63
SCF-1003 .....	45	SPK-710 .....	63
SCF-1003-TD .....	45	SPK-710-DBL .....	63
SCF-2003 .....	45	SR .....	9
SCH-1016A .....	53	SS2 .....	56
SCH-1016S .....	53	SS3 .....	56
SCH-2016A .....	53	STB-1007 .....	54
SCH-2016S .....	53	STB-2007 .....	54
SCK-1017 .....	50	TSB15 .....	9
SCK-2017 .....	50	W7317 .....	9
SCS-1014 .....	51	WOT-4200 .....	79
SCS-2014 .....	51	WRB1 .....	9, 40
SCS-1018 .....	52	WRB2 .....	9
SCS-1019 .....	52	WRB3 .....	63
SCT-1010 .....	55	WRB5 .....	9
SCT-2010 .....	55	WRB6 .....	9, 40
SHB-1004 .....	74	WRB8 .....	9
SHB-1004-NAT .....	74	WRB9 .....	9
SHC-1002 .....	74	WRB11 .....	9
SHF-1001 .....	75	WRB16 .....	9
SHH-1006 .....	75	WRB17 .....	9
SVC-1002 .....	74		
SVF-1001 .....	75		
SVV-1013 .....	75		
SHD1-AC1026CL-TYPE III-INCAN .....	6		
SHD1-AC1026CL-TYPE V-INCAN .....	6		
SHD1-PC1023CL .....	6		
SHD1-PC1026CL .....	6		
SMP-550 .....	62		
SP-12 .....	41		
SP-24 .....	41		
SP-36 .....	41		
SPB-170 .....	41		
SPB-190.....	9,40		
SPB-690 .....	9		
SPK-590 .....	61		
SPK-590-DBL .....	61		
SPK-591 .....	59		
SPK-591-DBL .....	59		
SPK-591-DB .....	59		
SPK-591-DB-DBL.....	59		
SPK-592 .....	61		
SPK-592-DBL .....	61		
SPK-600 .....	58		
SPK-600-DBL .....	58		
SPK-606 .....	58		
SPK-651 .....	60		



**SPECIAL LITE**  
QUALITY OUTDOOR PRODUCTS SINCE 1967



## Commercial & Residential Streetscape Solutions

Special Lite is also your manufacturing source for decorative traffic signage, wayfinding, entrance and informational signage.

Visit our website or contact us today to receive a Streetscape Solutions catalog.

### SPECIAL LITE PRODUCTS LLC

1634 Latrobe-Derry Road

Loyalhanna, PA 15661

Toll Free: 1-800-365-0511

Phone: (724) 537-4711

Fax: (724) 537-9313

[www.specialliteproducts.com](http://www.specialliteproducts.com)

[customer\\_service@specialliteproducts.com](mailto:customer_service@specialliteproducts.com)

Distributed By: